



User's Guide (for WEB)

GPS cycle computer

SGX-CA600

Introduction

Initial Setup

Basic Operations

Training

Using the Alert Notification Function

Using the Strava Live Segment Function

Using the Live Partner Function

Analyzing Log Data

Navigation

Pedaling Monitor

Bike and Sensor Settings

Advanced Settings

Linking with External Services

Frequently Asked Questions

Appendix

English

Contents

Introduction	6	Initial Setup	38
• Checking Accessories.....	6	• Performing the Initial Setup by Operating the Device	39
• Part Names and Functions.....	7	• Configuring the Settings in the App	42
– Front view.....	7	• Configuring the Settings on the Device.....	43
– Back view	9	– User Settings.....	43
• Name of Each Screen.....	9	– Bike Settings	43
– Meter screen	9	– Sensor Settings.....	43
– Main menu screen.....	10	– Wi-Fi Settings.....	43
• Button Operation in Each Screen and Screen Hierarchy	11	– Page Settings.....	43
– [←]/[→] buttons, [Confirm] but- ton, [Menu] button	11	– Map Download	43
– [Lap] button and [Power]/ [Logging] button	12	Basic Operations	44
– Screen hierarchy	13	• Operating the Meter Screen.....	44
• Viewing the Meter Screen.....	13	– Viewing Pages.....	44
– Page set.....	14	– Changing the Page.....	45
• Installation	15	– Enlarging the Display of a Data Field	46
– Installing the device.....	15	– Changing the Display Type of a Data Field.....	48
– Removing the device.....	20	– Displaying the Status.....	50
– Installing sensors.....	21	• Operating the Main Menu Screen	52
• Charging	21	– Viewing the Status Bar	54
– Charging the device	21	• Operation in the Spin Screen ...	54
– Checking the battery level	24	• Operation in the Text Input Screen	55
• Turning Power On/Off	26	• Performing Logging	57
– Turning power on.....	26	– Setting the Logging Interval... ..	59
– Turning power off.....	28	– Pausing and Resuming Logging Automatically.....	62
– Turning power off automatically if no operation is performed within a set time.....	29	– Notifying when Forget to Start Logging	66
– Switching to Sleep Mode	32		
– Switching to the sleep state automatically if no operation is performed within a set time....	33		

- Auto Lap Settings..... 70
- Uploading Log Data 74
 - About Cyclo-Sphere 74
 - Uploading via Wi-Fi 75
 - Uploading Using a PC 87
 - Uploading via Cyclo-Sphere Control App 88

Training.....91

- Training Overview 91
 - Clarifying the Areas You Wish to Strengthen..... 91
 - Types of Training Menus 92
 - Laps 94
 - Laying out an Appropriate Display for a Lap..... 94
 - Auto Lap Function 94
- Using Training Assistance 94
 - Creating a Training Menu of Training Assistance 95
 - Downloading the Training Menu of Training Assistance 95
 - Creating a Training Menu 95
 - Connecting the Device via Wi-Fi..... 96
 - Importing a Training Menu 96
 - Selecting an Imported Training Menu 98
- Starting/Ending a Training Menu..... 102
 - Forcibly Ending a Training Menu Part Way Through 104
 - Deleting a Training Menu..... 106
- Using a Link Menu 109
- Using an Original Menu..... 113
 - Selecting an Original Menu .. 113
 - Editing an Original Menu 116
 - Creating an Original Menu..... 118
- Measuring Your FTP 121

- Performing Training Based on Your MMP Data..... 128
 - Types of Threshold Training 128
 - Setting the MMP 129
- Automatically Switching to the Screen That Matches the Training Menu..... 141
- Setting the Countdown Timer. 142

Using the Alert Notification Function 145

- Configuring the Basic Settings of Alerts 145
 - Setting the Message and Sound..... 145
 - Power, Heart Rate, and Cadence..... 146
- Using the Auto Target Alert Function..... 149
- Using the Intensity Alert Function..... 152

Using the Strava Live Segment Function..... 156

- About Strava Live Segment ... 156
- Transferring a Strava Live Segment 156
- Using a Strava Live Segment While Riding..... 157
 - Riding to the Start Point of One of the Segments 159
 - Riding to the End Point of the Segment..... 160
- Disabling the Live Segment Function..... 160
- Automatically Switching to the Screen That Matches the Segment 162

• Using the Segment Alert Function.....	164	– Transferring from a Smartphone App.....	201
Using the Live Partner Function	166	– Transferring Course Files Using a PC	202
• Coach and Partner Configuration Patterns	166	• Selecting a Course.....	203
– Coach and Partner Communication Distance	166	– Selecting from the Transfer Folder.....	203
– Adding a Partner	167	– Selecting from past Log Data.....	206
– Adding a Coach.....	172	– Checking a Course	209
– Deleting a Partner or Coach	179	• Navigation Settings.....	214
– Viewing the Partner Screen .	182	• Starting and Stopping Navigation.....	217
– Option Settings of the Live Partner Function.....	186	• Simulation.....	218
Analyzing Log Data.....	189	– Smart Trainer Setting	218
• Displaying Log Data.....	189	– Starting and Stopping.....	220
• Editing Log Data	192	– Simulation Player	221
– Editing the Date and Time of Log Data.....	192	• Map Download.....	223
– Deleting Log Data.....	195	– Checking Map Information...	226
• Generating FIT Files	197	Pedaling Monitor.....	230
• Performing Analysis Using Cyclo-Sphere	197	• Initial Setup	230
– Cyclo-Sphere Analysis App (for iPhone).....	197	– Connecting	230
– Smartphone Version of the Cyclo-Sphere Website.....	198	– Configuring the Settings Using Cyclo-Sphere Control App ...	233
– PC Version of the Cyclo-Sphere Website	198	– Configuring the Settings on the Device	233
• Performing Analysis Using Strava	198	– Auto Zero Point Calibration .	249
• Performing Analysis Using TrainingPeaks.....	199	– Torque Assistance	252
Navigation	201	– Sprint Detection.....	255
• Transferring Courses	201	• Zero Point Calibration	258
– Ride with GPS Setup.....	201	Bike and Sensor Settings	263
– Strava Setup.....	201	• Changing the Bike.....	263
		• Connecting Sensors.....	265
		– Adding a Sensor	266
		– Checking the Settings of Added Sensors.....	270

- ANT+ Power Transmission Function Settings 277
- Bluetooth Power Transmission Function Settings 280
- Virtual Settings..... 283
- Di2 Remote Switch Setting 286
- Speed Priority Level Settings . 289
- GPS Setup..... 292
- Display Settings 294
- Sound Settings 296
- Gear Settings..... 298
- Bike Distance and Time Settings..... 300

Advanced Settings.....305

- Setting Data Fields..... 305
 - Layout Pattern List 307
 - Data Field Setting Details 310
- User Settings 336
- Average value setting 338
- System Settings..... 340
 - Performing Initialization 344
 - Making a Backup..... 344
 - Performing Restoration 345
 - Updating the Firmware 345
- Device Settings..... 346
- Wi-Fi Settings 349
- Bluetooth Setting 352

Linking with External Services356

- Strava 356
- Ride with GPS..... 356
- TrainingPeaks™ 356
- ZWIFT..... 356
- Smartphone Notification Function..... 356

- A-GPS Function..... 357

Frequently Asked Questions358

- Q: How can I return the language setting to English?..... 358
- Q: The vectors of the pedaling graph are not displayed. Is there a problem with the display?..... 358
- Q: Error 13 occurred during zero calibration. What does this error mean?..... 358
- Q: The operation buttons have become completely inoperable. Why? 358
- Q: How do I upload log data?. 358
- Q: Can you tell me how the time is set?..... 359
- Q: Why can I not connect with my smartphone via Bluetooth? 359

Appendix360

- Cautions Regarding Care, Storage, and Disposal..... 360
 - About Care and Storage..... 360
 - About Disposing of the Device 360
 - Replacing the Lithium-Ion Battery..... 360
 - Cautions When Recycling ... 360
- Warranty and After-Sales Service..... 362

Introduction

Checking Accessories

This product contains the following parts.

- Main unit

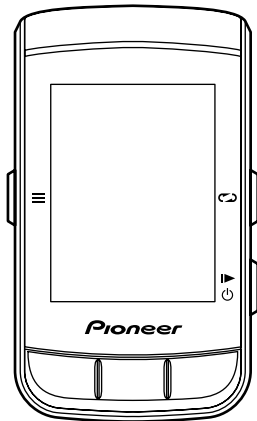

- Bracket

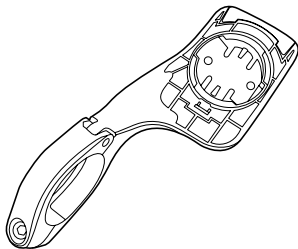

- USB cable

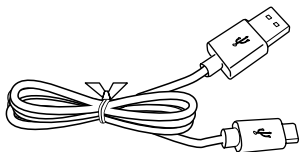

- Strap
- Safety Precautions
- Warranty Card

Part Names and Functions

■ Front view

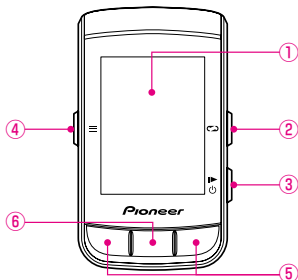

① Display

② **[Lap]** button

Press this button during logging to record a lap.

Press and hold this button for 2 seconds or more while logging is stopped to switch to the screen to save the log data.

Performing Logging

③ **[Power]/[Logging]** button

Press and hold this button for 2 seconds or more when the power of the device is off to turn the power on.

Press and hold this button for 2 seconds or more when the device is running to display the power off/sleep confirmation screen.

Press this button to start or stop logging.

④ **[Menu]** button

Press this button to display the main menu screen.

- Press this button when the main menu screen is displayed to return to the previous screen.
- Press this button when a data field is displayed enlarged to return to the meter screen.
- Press and hold this button for 2 seconds or more while the main menu screen is displayed to close the main menu.

⑤ **[←]/[→]** buttons

Used to perform operations such as changing the page and selecting an item.

⑥ **[Confirm]/[Enlarge]** buttons

Press this button when the main menu screen is displayed to confirm an item.

Press this button when the meter screen is displayed to display the data field at the top left enlarged.

However, large data fields such as the course display are enlarged first because they are given priority.

When this button is pressed during enlarged display, the next data field is displayed enlarged.

After 5 seconds of enlarged display, the display returns to the meter screen automatically.

Caution

- When the Capture function is enabled, the function to save log data by holding the [Lap] button is disabled.

■ Back view

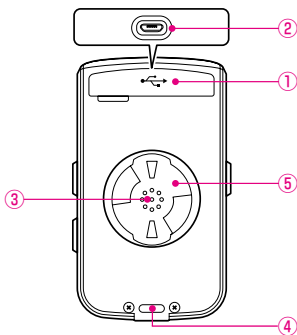

- ① USB connector cover
Securely close the USB connector cover when not charging the device or connecting to your PC.
- ② USB connector
Connect the USB cable to charge the device or transfer data to your PC.
- ③ Speaker
Outputs a buzzer sound when there is an alert or button operation.
- ④ Air pressure sensor
Do not block this sensor or the device will not operate properly.
- ⑤ Bracket installation slot
Use the bracket installation slot to attach the device on the bracket fixed to the bike.

Name of Each Screen

■ Meter screen

This is the main screen of the device for displaying the trip data of your bike. When you turn on the device, the meter screen is displayed first.

Operating the Meter Screen



■ Main menu screen

This is the main screen of the device for displaying various menus.

Operating the Main Menu Screen

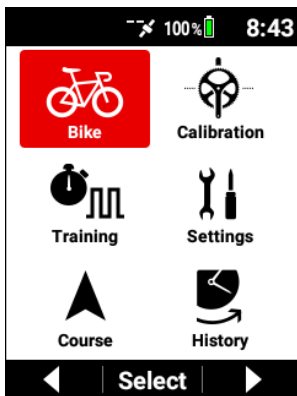

Button Operation in Each Screen and Screen Hierarchy

■[←]/[→] buttons, [Confirm] button, [Menu] button

The functions of the main unit buttons differ depending on the displayed screen

Operation in the menu screen

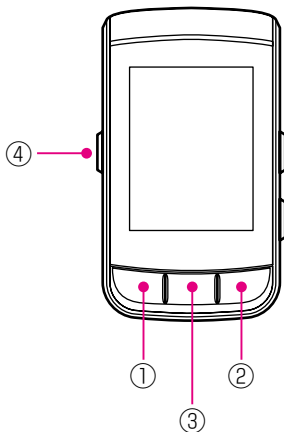

① [←] button	
② [→] button	Selects an item or value.
③ [Confirm] button	Confirms an item or value.
④ [Menu] button	Returns to the previous screen. Pressing and holding this button returns to the meter screen.

Operation in the meter screen

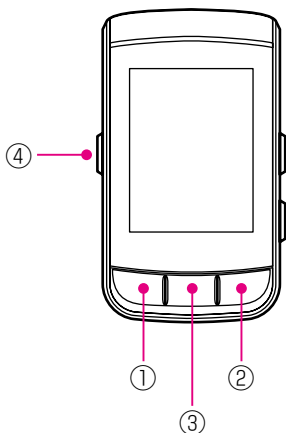

① [←] button	Changes the page.
② [→] button	
③ [Confirm] button	Enlarges or switches the data field. Press and hold to display the status screen. Press and hold during enlarged display to display the data field of the settings screen.
④ [Menu] button	Press this button during enlarged display to return to the meter screen.

■ [Lap] button and [Power]/[Logging] button

The [Lap] button and [Power]/[Logging] button can be operated in any screen.

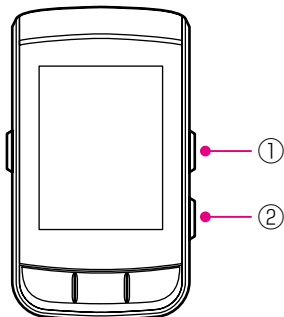

① **[Lap]** button

When logging: Records the lap.
When logging is stopped: Press and hold to save the logging data.

② **[Power]/[Logging]** button

When power is off: Press and hold to turn on the power.
When power is on: Starts/stops/resumes logging.
Press and hold to turn off the power or switch to the sleep state.

■ Screen hierarchy

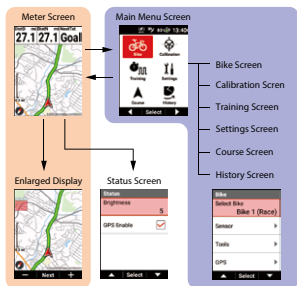

Viewing the Meter Screen

The meter screen consists of data fields to display various measurement data and pages to lay out and display the data fields.

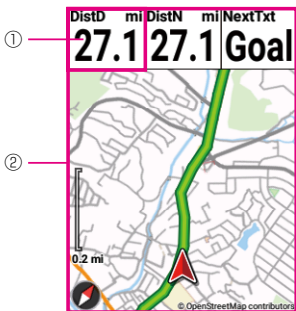

① Data field	The data to be displayed can be customized. Changing the Display Type of a Data Field
② Page	The number of data fields to display on a page and the layout can be customized. Setting Data Fields

■ Page set

A combination of multiple pages is called a page set.
Multiple page sets can be registered and accessed.

[Setting Data Fields](#)

PageSet1

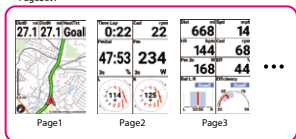

PageSet2

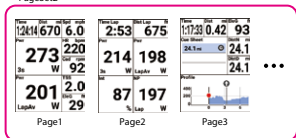

Note

- For details on the meter screen, refer to the following.
[Operating the Meter Screen](#)

Installation

Pioneer does not offer a guarantee for the use of brackets/mounts from other companies. Please check with the manufacturer of the bracket or mount.

■ Installing the device

Mount the device to your bike.

Caution

- When mounting the device, make sure your bike is in a stable position to prevent it from falling.

1 Remove the bolt from the bracket.

Remove the bolt from the bracket using a 3 mm hex wrench.

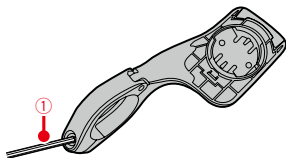

① Hex wrench

Be careful not to lose the removed bolt.

2 Mount the bracket on the handlebar of your bike.

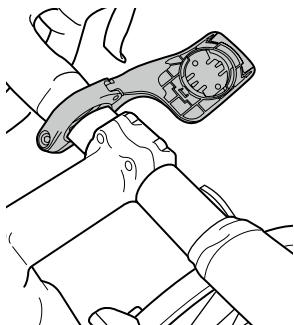

Caution

- Be careful not to pinch your finger when mounting the bracket on the bike.

3 Secure the bracket with the bolt.

Apply an anti-seize compound like grease to the bolt.
Adjust the bracket horizontally from the stem, insert the bolt into the hole and tighten lightly.

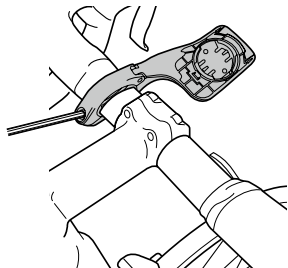

4 Attach the strap to the device.

Lace the strap through the strap holes of the device.

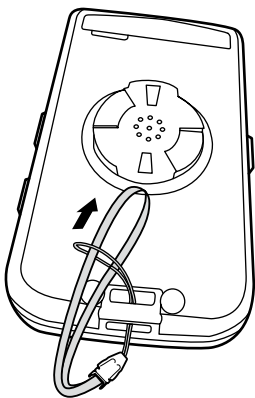

5 Attach the device to the bracket.

Fasten the strap to the handlebars, orient the device as shown in the figure, and align the two bracket installation slot projecting parts on the back of the device with the grooves in the bracket.

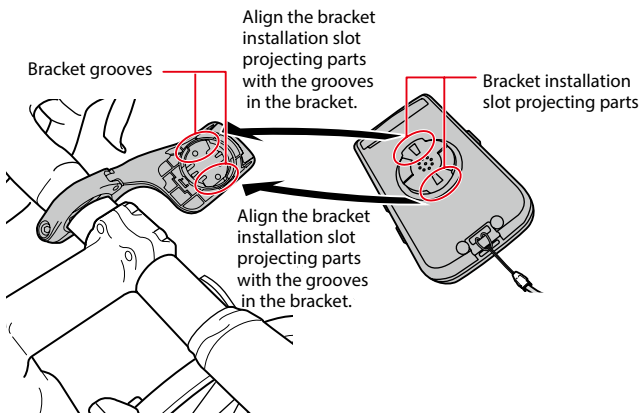

When the projecting parts are aligned with the grooves, the device will be at the angle shown in the figure below. Securely fit the two protruding parts into the grooves.

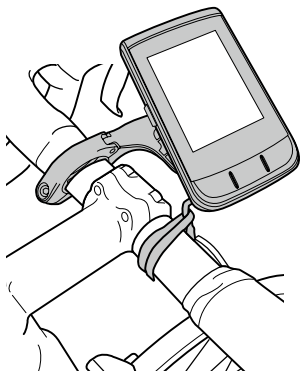

Turn the device clockwise until the device and bracket click, indicating that they are securely fixed together.

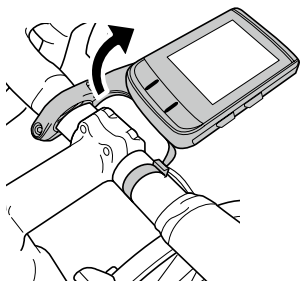

Caution

- Check that the front and rear protruding parts are inserted properly. Occasionally only one of them may be inserted. If only one of them is inserted, the main unit will not be securely fixed in place so there is a risk of the protruding parts being damaged or the main unit becoming detached.

Correct state

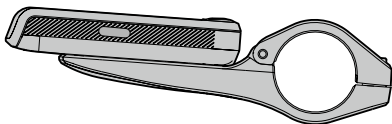

Incorrect state

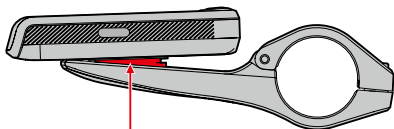

Main unit is raised up
because the protruding parts
are not inserted

6 Adjust the angle of the device and then secure the bracket.

If the device is not in the center of the handlebars or horizontal to the stem, loosen the bracket bolt and adjust it.

After adjusting the angle, secure the bracket by tightening the bolt that you tightened lightly.

Use a tool that can measure the torque to tighten the bolt.

Tightening torque: 0.6 N·m

Front view

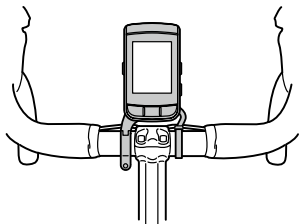

Side view

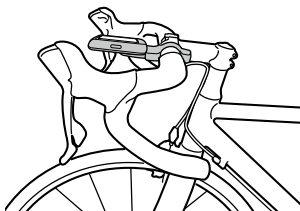

■ Removing the device

Turn the device counterclockwise until the device stops turning.

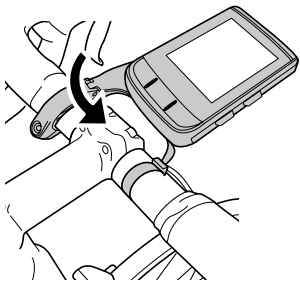

Turn the device all the way until it is as shown in the figure below and then lift it up slowly.

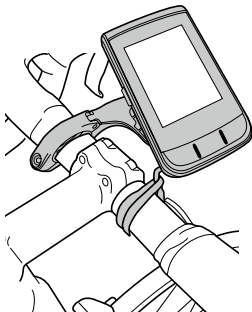

Caution

- Remove the device in the state in which it has been turned counterclockwise until it stops turning so that the bracket installation slot projecting parts on the back of the device are aligned with the grooves in the bracket. If you attempt to remove the device when it is turned part way, there is a risk of damaging the device bracket installation slot projecting parts or the bracket.
(For details on the installation slot projecting parts on the back and the grooves of the bracket, refer to “5. Attach the device to the bracket.” of “Installing the device.”)

■ Installing sensors

This device is compatible with ANT+™ sensors mounted on your bike.

Refer to the user's manual of your ANT+ sensors for mounting instructions.

After mounting a sensor, perform pairing with the device.

For details, refer to "[Connecting Sensors](#)."

This product is ANT+™ certified.

Visit <http://www.thisisant.com/directory/> for a list of compatible products and apps.



Charging

The internal battery of the device is not charged at the time of purchase.

Charge the device using the provided USB cable before using it.

■ Charging the device

- 1** Open the USB connector cover.

- 2** Connect the provided USB cable to the USB connector of the device.

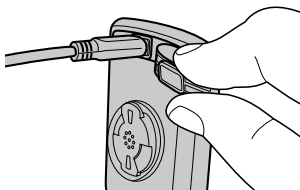

- 3** Turn your PC on and connect the USB cable to an open USB port on your PC.

The device starts charging.

- When the device is off

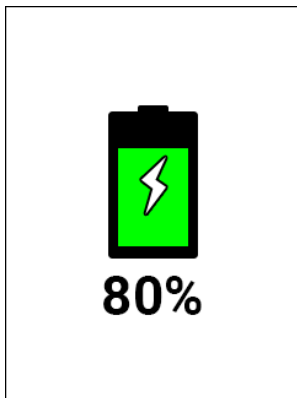

- When the device is on

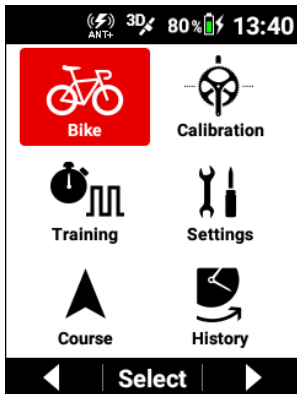

Press and hold the [Power] button for 2 seconds or more to turn the power on or off during charging.

The charging time is shorter if the power is turned off.

Charging icons



Charging



Fully charged

Note

- The device takes about 4 hours to fully charge (when the power is off or normal charging).
- When the device is turned off, the screen turns dark after 5 seconds. To check the charge state and battery level, press the [**Power**] button.

- For safety reasons, the device will not charge in an environment outside the charging temperature range (0°C to 45°C).
If the internal temperature of the device is too high, charging may not be possible even when the ambient temperature is within range.
In this case, turn off the device, allow time to cool down and recharge.
- Connect the provided USB cable directly to a USB port of your PC.
If the device is connected via a USB hub, charging may not be possible due to insufficient capacity.
Make sure that the USB output of your PC is compatible with 5 V/500 mA.
- Do not unplug the USB cable, shut down the PC or put it to sleep, suspend the power supply to the USB, etc. during access between the device and PC as there is a risk of corrupting data in the device.

4 Unplug the USB cable from the USB port.

Once data transfer or charging is complete, disconnect the USB cable from the PC first, and then from the device.

5 Close the USB connector cover.

Securely close the USB connector cover.

If the cover is not securely closed, waterproof performance may be impaired.

■ Checking the battery level

You can check the battery level from the battery level icon displayed on the status bar of the main menu screen.

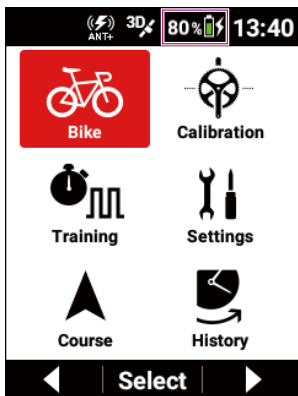

Note

- When the battery level becomes low, the **"Battery Level Decreasing"** message appears.
If the battery level is allowed to become even lower, the device will shut down automatically.
- Battery power consumption can be reduced by using combination of the power saving mode, auto power off, and auto sleep.
[Low Energy Mode](#)
[Auto Power Off](#)
[Auto Sleep](#)
- You can also check the battery level on the device settings screen.
[Device Settings](#)

Estimate of possible operating time

This device can be used for approximately 12 hours with a fully charged battery.
(In case of screen brightness 3)

Note

- The possible operating time may become shorter depending on the operating conditions.

- If the possible operating time after charging is abnormally short, the battery may need to be replaced.

For details, please visit our website.

<http://www.pioneerelectronics.com>

<http://www.pioneerelectronics.ca>

www.pioneer-car.eu

Turning Power On/Off

■ Turning power on

- 1** Press and hold the [Power] button for 2 seconds or more.

An opening message appears and then the meter screen is displayed automatically.

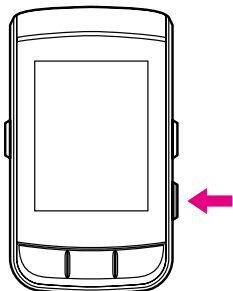

■ Turning power off

- 1 Press and hold the [Power] button for 2 seconds or more.

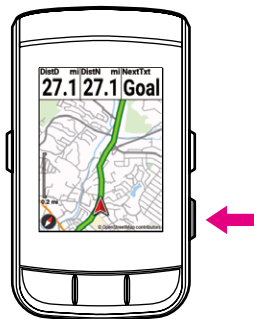

- 2 Press the [Confirm] button.

A shutdown message will appear and the power turns off.

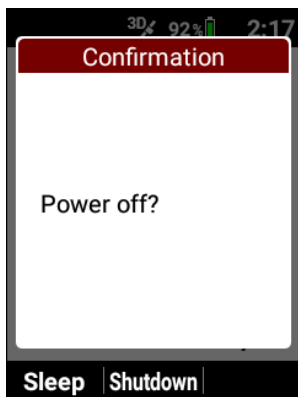

■ Turning power off automatically if no operation is performed within a set time

You can set the device to turn off automatically if no operation is performed within a set time.

- 1** Press the [Menu] button.
- 2** Use the [←]/[→] buttons to select [Settings] and then press the [Confirm] button.

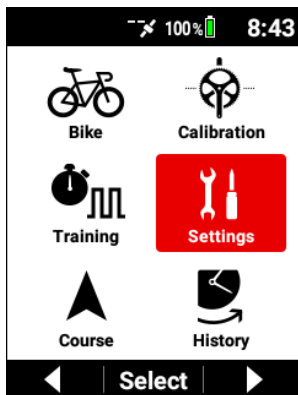

- 3** Use the [←]/[→] buttons to select [Device] and then press the [Confirm] button.

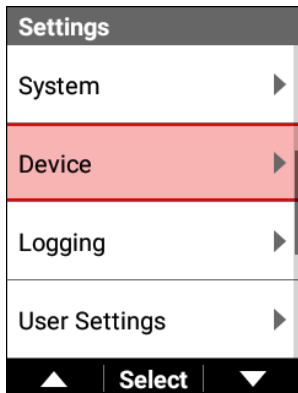

- 4** Use the [←]/[→] buttons to select [Auto Power Off] and then press the [Confirm] button.

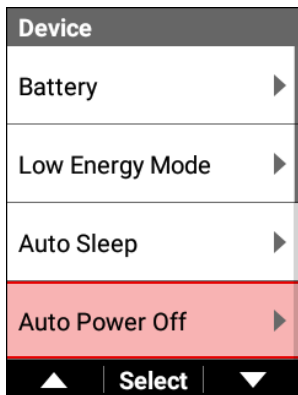

- 5 Press the [Confirm] button to select the [Enable] check box.

Auto Power Off	
Enable	<input checked="" type="checkbox"/>
Power Off Time	6 hour
▲	Select ▼

- 6 Use the [←]/[→] buttons to select [Power Off Time] and then press the [Confirm] button.

Auto Power Off	
Enable	<input checked="" type="checkbox"/>
Power Off Time	6 hour
▲	Select ▼

- 7** Press the [←]/[→] buttons and [Confirm] button to set the time to wait until turning the power off.

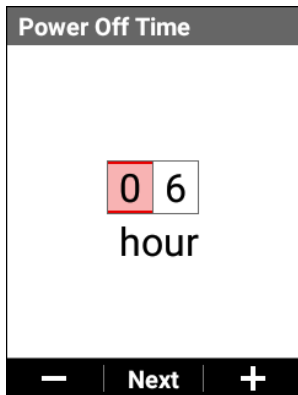

- 8** Press the [Confirm] button.

Switching to Sleep Mode

When the device is switched to the sleep state, the screen turns off to minimize battery consumption.

You can return to the power-on state immediately by pressing any button other than the [←]/[→] buttons.

Use this feature when, for example, you take a lunch or other break or when your bike is standing by for the transition from swimming to cycling during a triathlon.

Note

- If a Pedaling Monitor, Power Meter, or Smart Trainer in the Sensor List of the currently selected bike are enabled, apply over 5 watts of power or produce a cadence value of 30rpm or more to recover from sleep mode automatically.

- 1 Press and hold the [Power] button for 2 seconds or more.

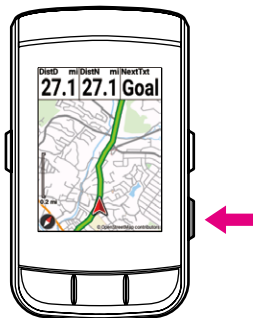

- 2 Press the [←] button.

A message is displayed and the device switches to sleep state.

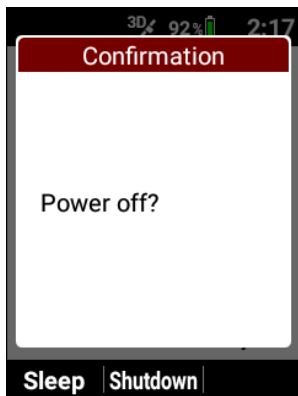

■ Switching to the sleep state automatically if no operation is performed within a set time

You can set the device to switch to the sleep state automatically if no operation is performed within a set time.

This is set to [30 min] by default.

- 1 Press the [Menu] button.**
- 2 Use the [←]/[→] buttons to select [Settings] and then press the [Confirm] button.**

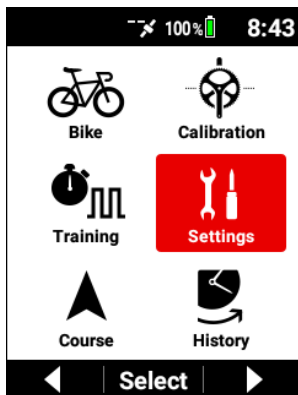

- 3** Use the [←]/[→] buttons to select [Device] and then press the [Confirm] button.

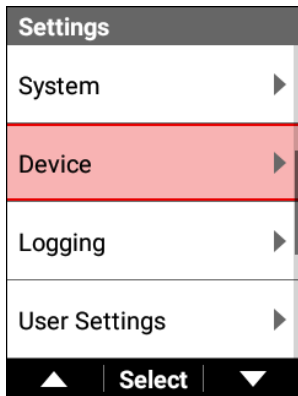

- 4** Use the [←]/[→] buttons to select [Auto Sleep] and then press the [Confirm] button.

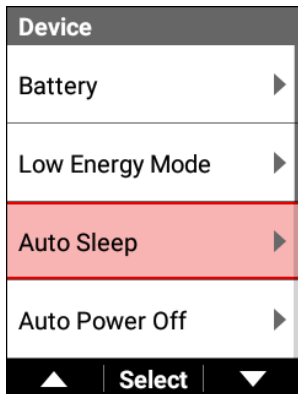

- 5 Press the [Confirm] button to select the [Enable] check box.

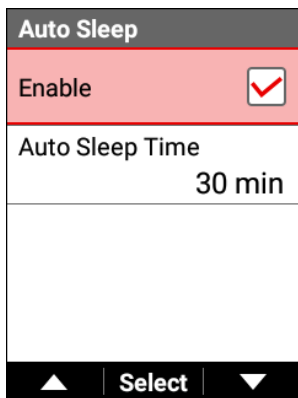

- 6 Use the [←]/[→] buttons to select [Auto Sleep Time] and then press the [Confirm] button.

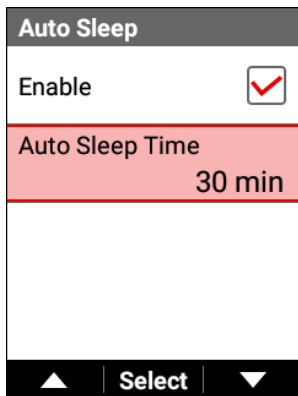

- 7** Press the [←]/[→] buttons and [Confirm] button to set the time to wait until switching to the sleep state.

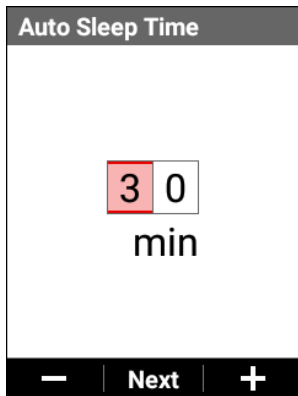

- 8** Press the [Confirm] button.

Note

- Sleep state will not engage during logging even if no operation continues.

Initial Setup

When you turn the device on for the first time after purchase, the initial setup screen is displayed.

First, a QR code is displayed prompting you to go to the download site for the Cyclo-Sphere Control App, which is an app for smartphones.



The initial setup can also be performed by installing the Cyclo-Sphere Control App on your iPhone or Android device and then performing the initial setup in the app.

In this case, the initial setup procedure on this device will not be necessary because the meter screen will be displayed when synchronization with the device is confirmed.

To perform the initial setup by operating the device, press the [→] button to go to the next screen.

There are a total of three pages in the initial setup (language setting → date and time setting → unit system setting).

Note

- To change the language of the screen displaying the QR code, press the [←] button and select the language.

Performing the Initial Setup by Operating the Device

Set the desired display language for the device.

The following languages can be selected.

English/日本語/Français/Español/繁體中文/Nederlands/Deutsch/Italiano

The language is set to [English] by default.

- 1 Press the [Confirm] button.**

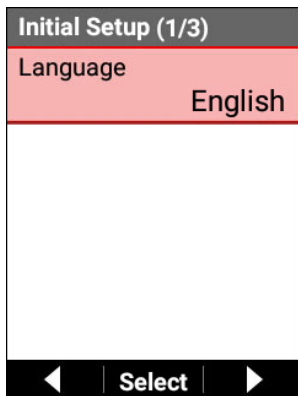

- 2** Use the [←]/[→] buttons to select a language and then press the [Confirm] button.



The selected language is confirmed.
Press the [→] button to go to the next screen.

- 3** Press the [Confirm] button.



The following items can be set.

Setting item	Description
Time Zone	Select a time zone.
Smartphone Cooperation	Select this check box to link with the Cyclo-Sphere Control App, which is an app for smartphones, and the time zone of the device will automatically be set to the time zone of the smartphone.
Date	Enter the date.
Time	Enter the time. Enter the time in 24-hour format for the time setting regardless of whether or not the [24-Hour Format] check box is selected.
24-Hour Format	Check the box to display time in 24-hour format.
Date Format	Select the date format.

Note

- The date and time settings are updated automatically when a GPS signal is received before logging starts and after log data is saved.
- If the time zone setting is incorrect, the time may be off by the time zone amount after a GPS automatic update even when the time has been set.
- The time zone can also be set automatically using the Cyclo-Sphere Control App, which is an app for smartphones. For details, refer to the following website.
<https://cyclo-sphere.com/app/>
- If logging is started in the factory default state, the "The Date & Time are incorrect." message will be displayed. If logging is started while the date is incorrect, you can change the date and time in the history after the log data is saved.
- The format selected for the date format is reflected in the date indications of data fields and in the setting for your date of birth. It is not reflected in the file name of the log data.

4 Press the [Menu] button.

The initial setup (2/3) screen reappears.

Press the [→] button to go to the next screen.

5 Press the [Confirm] button.

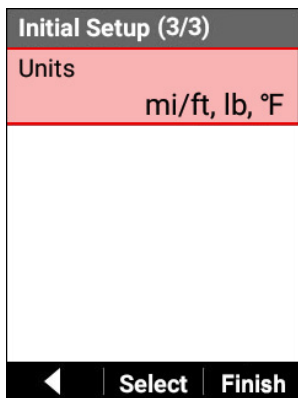

The following items can be set.

Setting item	Description
km, kg, °C	Set the unit system indications to kilometers, kilograms, and Celsius.
mi/ft, lb, °F	Set the unit system indications to miles/feet, pounds, and Fahrenheit.

This is set to [mi/ft, lb, °F] by default.

6 Press the [→] button.

The initial setup completion message appears. To complete the initial setup, press the [Confirm] button. The device starts and the meter screen appears.

To redo the initial setup, press the [←] button.

Configuring the Settings in the App

Configuration of the settings is simpler if you use the Cyclo-Sphere Control App. The settings can be automatically synchronized with the device.

For details, refer to the following website.

<https://cyclo-sphere.com/app/>

Configuring the Settings on the Device

The settings can also be configured from the main menu of the device without using the Cyclo-Sphere Control App.

We recommend configuring the following settings before using the device.

■ User Settings

Register basic information such as your user name and sex, information related to your power level and heart rate, and other information.

[User Settings](#)

■ Bike Settings

Register information related to each of your bikes.

[Bike and Sensor Settings](#)

■ Sensor Settings

Configure various settings related to sensors.

[Bike and Sensor Settings](#)

■ Wi-Fi Settings

Configure settings related to Wi-Fi such as switching the Wi-Fi connection and adding an access point.

[Wi-Fi Settings](#)

■ Page Settings

The page layout and display items can be customized to match your preference.

[Setting Data Fields](#)

■ Map Download

Download map data to the device.

[Download map data to the device.](#)

Basic Operations

This section describes how to view and use the meter screen, the main screen of the device, and how to perform logging to record information such as the elapsed time, various sensor information, and GPS position information.

Operating the Meter Screen

The meter screen is the main screen of the device for displaying trip data. When you turn on the device, the meter screen is displayed first.



Note

- To display the meter screen from the main menu screen, press the [Menu] button.

■ Viewing Pages

The meter screen consists of multiple pages and data fields.

Various information is displayed on the pages on a data field basis.

- Data field
A data field shows the label, sub-label, unit and other details of the displayed information.

The content to display in a data field can be selected from the data categories of graph parts and numerical value parts depending on the size of the data field.

Furthermore, customization is possible depending on the data type and display type.

Example: Numerical type

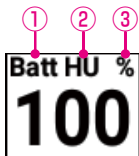

- ① Label
- ② Sub-label
- ③ Unit

- Page

A screen on which data fields are placed.

The number of data fields to display and the layout on each page can be edited as desired to match the purpose of use.

[Setting Data Fields](#)

■ Changing the Page

Change the page to display.

1 Press the [←]/[→] buttons.

Each press changes the page.

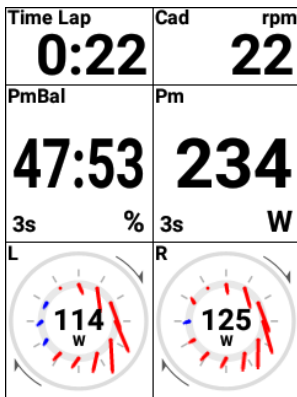

■ Enlarging the Display of a Data Field

Enlarge the display of a data field displayed on a page.

- 1** Press the [Confirm] / [Enlarge] button.

The data field is displayed enlarged.

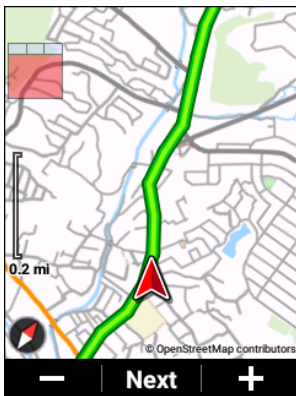

When you display a data field enlarged, a thumbnail of the layout will be displayed at the top left for the first 2 seconds. The place focused in red is the data field currently displayed enlarged.

Operation during enlarged display is as follows.

Pressing the [Confirm]/[Enlarge] button in the data field displayed when “Next” at the bottom of the page is pressed continues enlarged display and displays the next data field.

Pressing the [←]/[→] button in the data field displayed when “-” /” +” or “▲” /” ▼” at the bottom of the page is pressed enables the next operation according to the displayed data field.

Course of a graph part: Changing the details/broad area of the map scale displayed

Cue sheet of a graph part: Returning/Sending a cue sheet

Profile of a graph part: Changing the profile distance

Pressing the [Confirm]/[Enlarge] button in the data field displayed when “Close” at the bottom of the page is pressed ends enlarged display and returns to normal display.

If no operation is performed, normal display returns after approximately 5 seconds.

■ Changing the Display Type of a Data Field

You can change the category, unit, type, and other settings for the data displayed in a data field.

1 Press the [Confirm] button.

The data field is displayed enlarged.



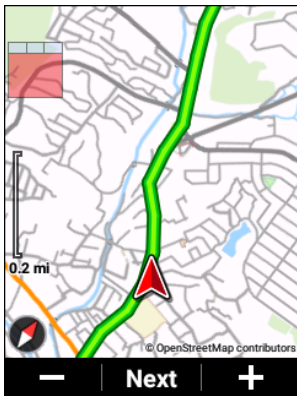

- 2** Press the [Confirm] button until the data field for which you wish to change the display type appears and then press and hold the [Confirm] button.

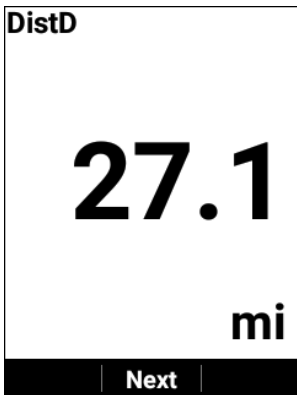

#2
Data Field Type Numerical
Data Category Course
Data Type Distance Destination
Display Type mile
▲ ▼

Use the [←]/[→] buttons to select the desired display type and then press the [Confirm] button.

When the settings are finished, press the [Menu] button to return to the meter screen.

■ Displaying the Status

In the status display, you can set the screen brightness and GPS settings. The sensor connection status is displayed below these settings.

- 1 Press and hold the [Confirm] button for 2 seconds or more.



The status screen appears.

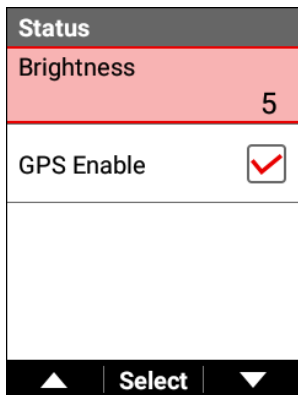

Operating the Main Menu Screen

You can configure various settings of the device in the main menu screen..

- 1 Press the [Menu] button.
- 2 Use the [←]/[→] buttons to select a main menu item and then press the [Confirm] button.

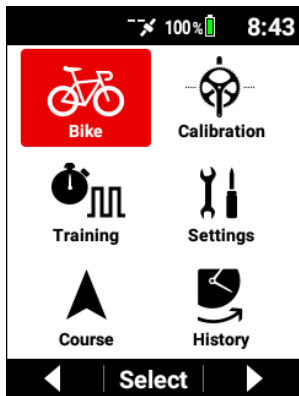

The settings screen for the selected main menu item appears.



Select the bike to be used and configure various settings for the bike. For details, refer to "[Bike and Sensor Settings](#)."



Zero point calibration of pedaling monitor sensor or ANT+power meter is performed. For details, refer to "[Zero Point Calibration](#)".



Training

Configure settings and perform operations related to training such as creating a training menu and starting training. For details, refer to "[Training](#)."



Settings

Configure various settings related to Wi-Fi, Cyclo-Sphere, and the device. For details, refer to "[Advanced Settings](#)."



Course

Configure settings and perform operations related to courses such as selecting a course and downloading a map. For details, refer to "[Transferring Courses](#)," and "[Selecting a Course](#)".



History

Analyze and edit past log data records. For details, refer to "[Analyzing Log Data](#)".

■ Viewing the Status Bar

You can check the statuses of the device from the icons displayed on the status bar at the top of the main menu screen.

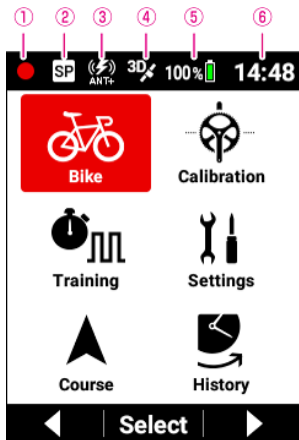

① Logging status

No icon: Before logging starts or after log data is saved

■: Logging

▨: Logging paused

■: Logging stopped

② Sprint detection status

③ ANT+/Bluetooth® power transmission status

"ANT +" when ANT + power transmission is enabled, "BT" when Bluetooth power transmission is enabled, "ANT + BT" when both are enabled is displayed.

④ GPS reception status

⑤ Battery status

⑥ Current time

Operation in the Spin Screen

A screen for selecting the current value from predetermined items such as dates is called a spin screen.

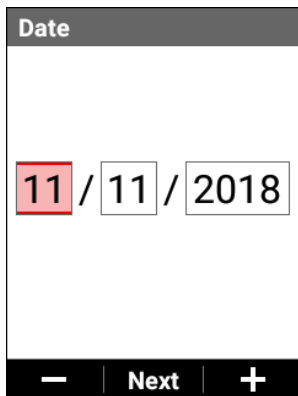

(Example: Date setting screen)

Each press of the [←]/[→] buttons changes the value of the selected item, and each press of the [Confirm] button changes the selected item.

Operation in the Text Input Screen

Text input operation on the device is performed by first selecting the character type in the type selection screen and then entering text by selecting the desired text in the displayed text input screen.

- 1** Use the [←]/[→] buttons to select the character type and then press the [Confirm] button.

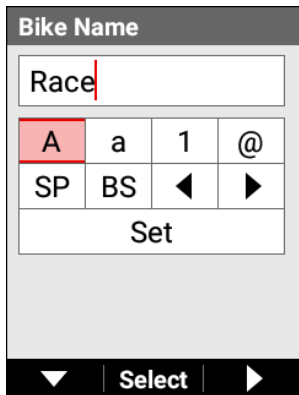

(Example: Bike name input screen)

A: Displays the alphabet letter list screen (uppercase).

a: Displays the alphabet letter list screen (lowercase).

1: Displays the number list screen.

@: Displays the symbol and other character list screen.

SP: Enters a space.

BS: Deletes one character at a time.

<: Moves the text input cursor position to the left.

>: Moves the text input cursor position to the right.

[Set]: Saves the entered text and ends text input.

- 2** Use the [←]/[→] buttons to select text and then press the [Confirm] button.

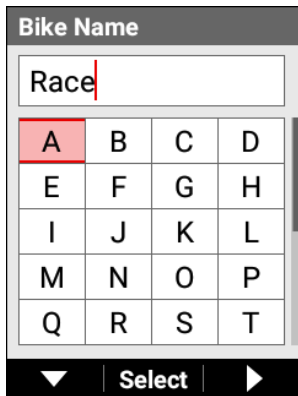

(Example: When selecting character type "A")

Aa1@: Saves the entered text and returns to the type selection screen.

[Set]: Saves the entered text and ends text input.

Note

- If you press the [Menu] button in the type selection screen, the entered text is discarded (returns to the state before input) and text input ends.
- If you press the [Menu] button in the text input screen, the entered text is saved and the type selection screen reappears.

Performing Logging

Recording information such as the elapsed time, various sensor information, and GPS position information is called "logging."



- 1** Press the [Logging] button.

[Logging Started] is displayed and logging starts.

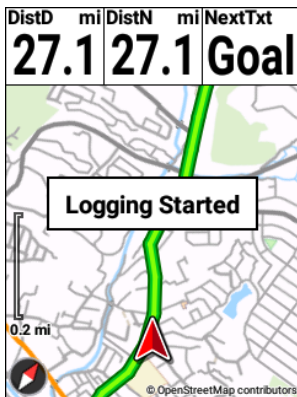

2 Press the [Logging] button during logging.

Logging stops and the save confirmation message appears.

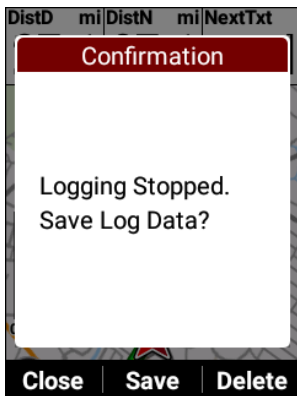

If you press the [Confirm] button, the log data is saved and the meter screen reappears.

If you press the [←] button, the message closes and the meter screen reappears while logging remains in the stopped state.

When you wish to start logging, press the [Logging] button again.

If you press the [→] button, the log data deletion confirmation message appears.

If you press the [Confirm] button, the log data is deleted and the meter screen reappears.

Note

- You can also save the log data by pressing and holding the [Lap] button for 2 seconds or more in the logging stopped state.
- When the capture function is enabled, the function to save the logging data by pressing and holding the [Lap] button while logging is stopped will not work.

■ Setting the Logging Interval

The device saves the various data during logging at a set interval.

Select from [Auto], [1 sec]*, [3 sec], [5 sec], and [10 sec] for the setting.

If the interval is set to [Auto], the logging interval becomes shorter when the riding speed of the bike increases and longer when the riding speed decreases.

*: Factory default setting

Note

- The maximum file size for log data that can be analyzed in Cyclo-Sphere is 16 MB.
The file size for one hour of log data is approximately 1 MB.
The size differs depending on the sensors connected and settings.
- When performing logging for a long time such as on a long ride or when randonneuring, we recommend setting this to [3 sec] or [Auto].

1 Press the [Menu] button.

- 2 Use the [←]/[→] buttons to select [Settings] and then press the [Confirm] button.

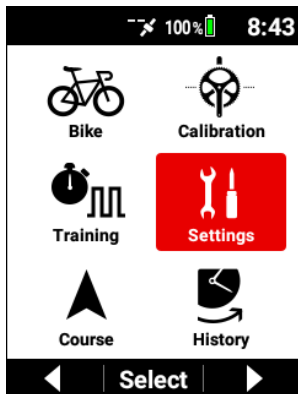

- 3 Use the [←]/[→] buttons to select [Logging] and then press the [Confirm] button.

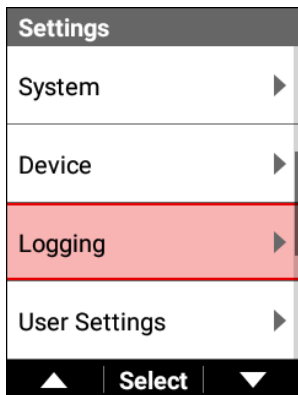

- 4 Use the [←]/[→] buttons to select [Logging Interval] and then press the [Confirm] button.

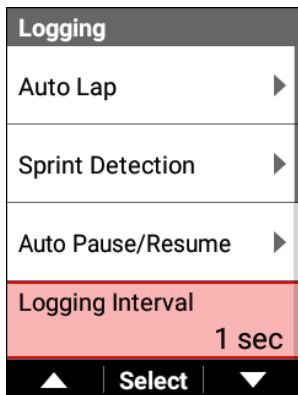

- 5 Use the [←]/[→] buttons to select the desired setting and then press the [Confirm] button.

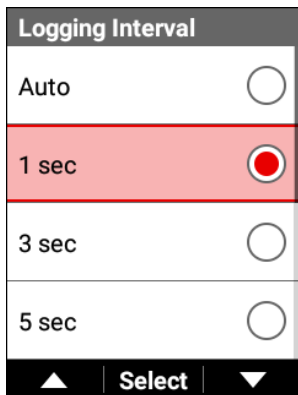

6 Press the [Menu] button.

Setting finishes.

■ Pausing and Resuming Logging Automatically

You can use the Auto Pause/Resume function to pause/resume logging automatically when a certain speed is reached during logging.

For example, if you wish to automatically pause logging when the ride speed decreases to 3 km/h* or slower and resume logging when the ride speed becomes faster than 3 km/h, enable [Auto Pause/Resume] and set [Trigger Threshold] to 3.0.

*: Factory default setting

Setting the Auto Pause function

1 Press the [Menu] button.

2 Use the [←]/[→] buttons to select [Settings] and then press the [Confirm] button.

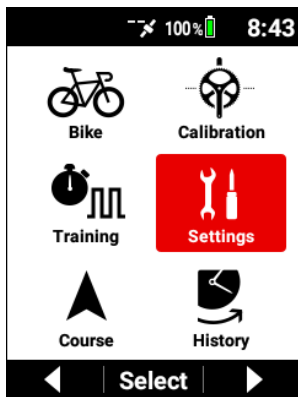

- 3** Use the [←]/[→] buttons to select [Logging] and then press the [Confirm] button.

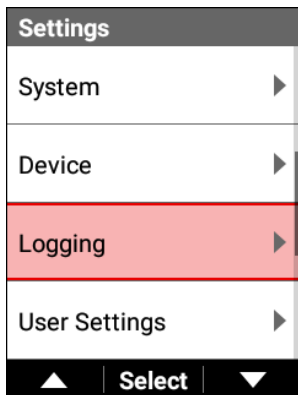

- 4** Use the [←]/[→] buttons to select [Auto Pause/Resume] and then press the [Confirm] button.

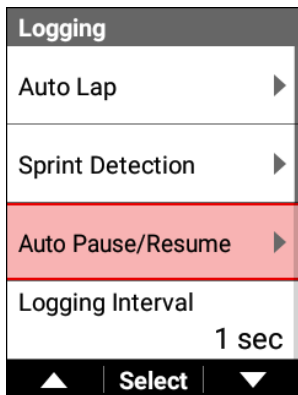

- 5** Use the [←]/[→] buttons to select [Enable] and then press the [Confirm] button.

Auto Pause/Resume	
Enable	<input checked="" type="checkbox"/>
Trigger Threshold	1.8 mph
▲	Select ▼

The "Enable" check box is selected and the Auto Pause/Resume function turns on.

To turn it off, press the [Confirm] button again to clear the check box.

- 6** Use the [←]/[→] buttons to select [Trigger Threshold] and then press the [Confirm] button.

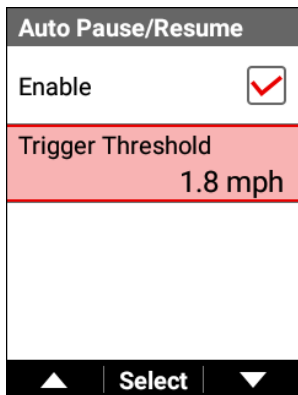

- 7** Use the [←]/[→] buttons to set the speed at which the Auto Pause function works and then press the [Confirm] button.

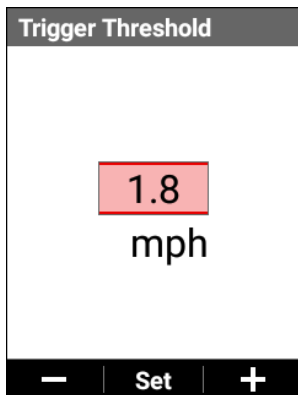

8 Press the [Menu] button.

Setting finishes.

Note

- The Auto Pause function may not work properly when using GPS speed while using rollers or when there is no speed sensor.

■ Notifying when Forget to Start Logging

You can use the Reminder function to display a message if you start a ride and have not started logging.

Set the operation interval of the Reminder function as desired.

Select from [10 sec], [30 sec], and [1 min]* for the setting.

*: Factory default setting

Note

- The Reminder function reminds you not only before logging starts but also when you resume a ride from the logging stopped state.
- The Reminder function determines you are riding by one of the values of speed, cadence, or power.
It may not operate depending on the GPS Speed setting, or the conditions of the sensor connection or GPS reception.
- If you wish to perform logging when the “Press start to record” message is displayed by the Reminder function, press the [Logging] button to start or resume logging.

1 Press the [Menu] button.

- 2** Use the [←]/[→] buttons to select [Settings] and then press the [Confirm] button.

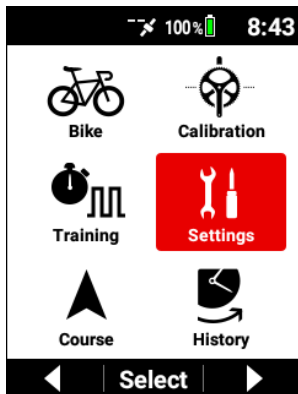

- 3** Use the [←]/[→] buttons to select [Logging] and then press the have not [Confirm] button.

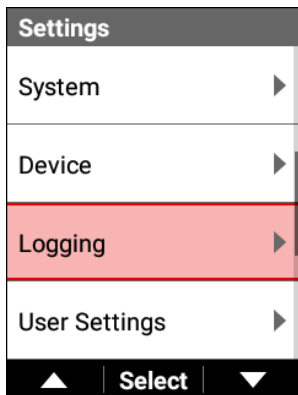

- 4 Use the [←]/[→] buttons to select [Reminder] and then press the [Confirm] button.

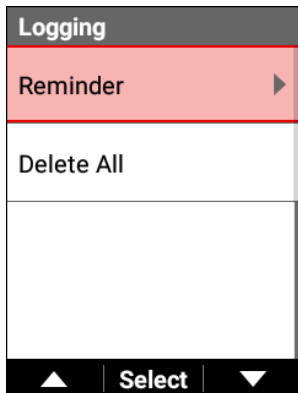

- 5 Use the [←]/[→] buttons to select [Enable] and then press the [Confirm] button.

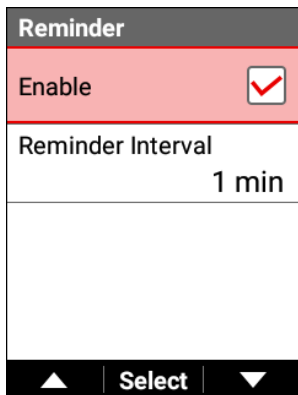

The "Enable" check box is selected and the Reminder function turns on.

To turn it off, press the [Confirm] button again to clear the check box.

- 6** Use the [←]/[→] buttons to select [Reminder Interval] and then press the [Confirm] button.

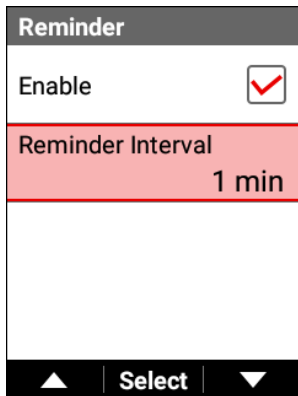

- 7** Use the [←]/[→] buttons to select the operation interval of the Reminder function and then press the [Confirm] button.



8 Press the [Menu] button.

Setting finishes.

Auto Lap Settings

The Auto Lap function automatically records a lap without requiring the Lap button to be pressed, whenever a preset time, distance, or point is attained.

Note

- The Auto Lap function operates only while logging is in progress. It does not operate if logging is stopped or in auto pause.

1 Press the [Menu] button.

2 Use the [←]/[→] buttons to select [Settings] and then press the [Confirm] button.

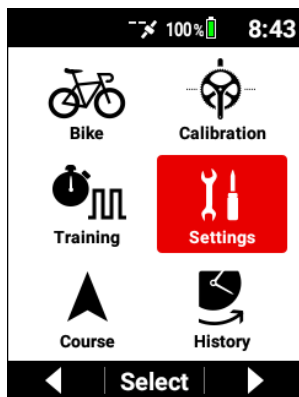

- 3** Use the [←]/[→] buttons to select [Logging] and then press the [Confirm] button.

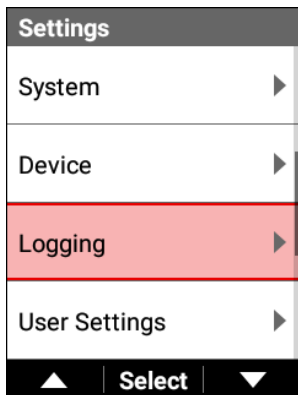

- 4** Use the [←]/[→] buttons to select [Auto Lap] and then press the [Confirm] button.

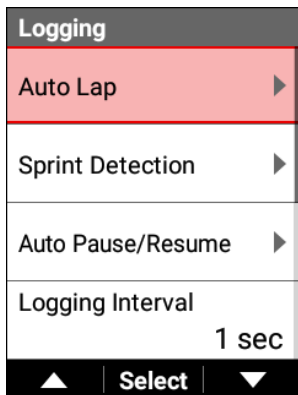

Auto Lap	
Enable	<input type="checkbox"/>
Auto Lap Trigger	Time
Interval Time	0:03:00
<div style="display: flex; justify-content: space-between; align-items: center;"> ▲ Select ▼ </div>	

Setting item	Description
Enable	Enable or disable* Auto Lap.
Auto Lap Trigger	Use the procedure below to specify the conditions (Auto Lap Trigger) by which the Auto Lap function records a lap. You can select [Location], [Distance], or [hour]* as a auto lap trigger.

*: Factory default setting

The setting items below can be specified according to the selected auto lap trigger.

Auto Lap Trigger	Setting item	Description
[Location]	Lap Location	Registers a point as an auto lap location where the [Lap] button is pressed while logging is in progress, and from the next time when passing nearby the auto lap location, records a lap automatically.
	Logging Start Location	Registers the logging starting point as an auto lap location when passing nearby the logging starting point, location, records a lap automatically.
	Registered Location	Records a lap at the auto lap location registered with the [Registered Location] button.
	Trigger Area Size	Specify the distance from the auto lap location in which the system records a lap. For example, set [50 m] to record a lap when approaching to within a 50 m radius of the location.
	Register Location	Press to register an actual point as an auto lap location.
[Distance]	Interval Distance	Records a lap when a preset lap distance is attained.
[Time]	Interval Time	Records a lap when a preset lap time is attained.

Note

- You can register up to 10 auto lap locations by using the [Logging] or [Lap] button.
- You can register only 1 location by using the [Register Location].
- The auto lap locations will be cleared when the timer is reset.

- You can manually press the [Lap] button to record a lap, even while autowrap is enabled. When the lap type of auto lap is [Location] and lap point is enabled, registration of auto lap point and lap recording are performed simultaneously.
- If GPS is not being received, the registration of auto lap locations by using the [Logging] or [Lap] button, or user locations by using the [Lap Location] are not available.

Uploading Log Data

You can upload the log data stored in the built-in flash memory of the device to the Cyclo-Sphere analysis service for analysis.

There are the following three ways to upload log data.

- Uploaded via Wi-Fi from the device
■ Uploading via Wi-Fi
- Upload using a PC
■ Uploading Using a PC
- Upload via the Cyclo-Sphere Control App
■ Uploading via Cyclo-Sphere Control App

■ About Cyclo-Sphere

This is a free web service to upload the log data of the device and then perform detailed data analysis.

The service can be accessed with a web browser or dedicated application.

Recommended web browsers

Windows

- Google Chrome
- Mozilla Firefox

Macintosh

- Google Chrome
- Mozilla Firefox
- Apple Safari

Recommended web browsers for the page designed for smartphones

iPhone 7/iPhone 7 Plus

- Safari

Application for iPhone

Cyclo-Sphere Analysis App

■ Uploading via Wi-Fi

Creating a Cyclo-Sphere account

Register from the following URL.

cyclo-sphere.com

Setting Your Cyclo-Sphere Account

Set the user account of Cyclo-Sphere for uploading the log data via Wi-Fi.

If you are using Google etc for the account, configure the account settings from the Cyclo-Sphere Control App on your iPhone or Android device.

Only account settings using an e-mail address can be set on the device.

- 1 Press the [Menu] button.**
- 2 Use the [←]/[→] buttons to select [Settings] and then press the [Confirm] button.**

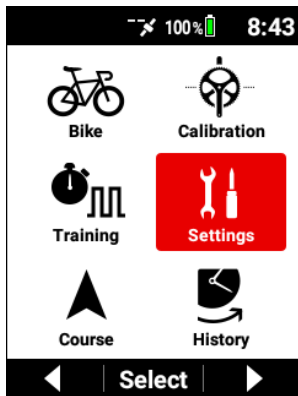

- 3** Use the [←]/[→] buttons to select [Cyclo-Sphere] and then press the [Confirm] button.

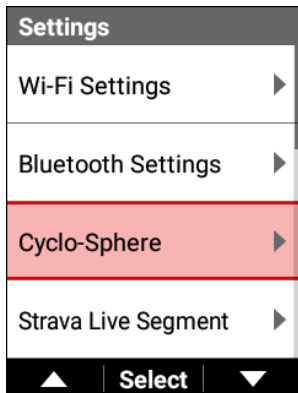

- 4** Use the [←]/[→] buttons to select [Account] and then press the [Confirm] button.

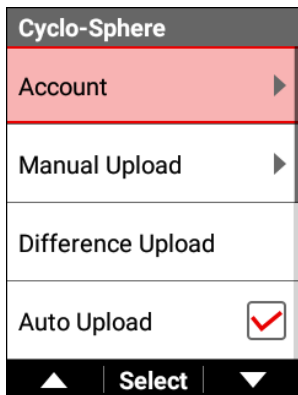

- 5** Use the [←]/[→] buttons to select [Email Address] and then press the [Confirm] button.

Account
Email Address
Password
Login

▲ | Select | ▼

- 6 Use the [←]/[→]/[Confirm] buttons to enter an e-mail address.

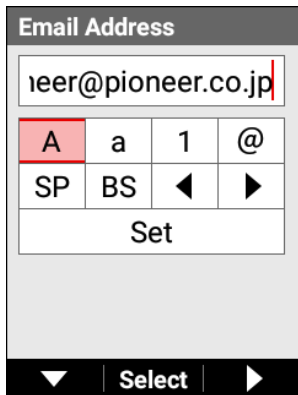

Select the "Set" key on the keyboard and then press the [Confirm] button to return to the previous screen.

Operation in the Text Input Screen

- 7** Use the [←]/[→] buttons to select [Password] and then press the [Confirm] button.

Account
Email Address
Password
Login

▲ | Select | ▼

- 8** Use the [←]/[→]/[Confirm] buttons to enter a password.

Select the "Set" key on the keyboard and then press the [Confirm] button to return to the previous screen.

Operation in the Text Input Screen

- 9** Use the [←]/[→] buttons to select [Login] and then press the [Confirm] button.

If login is successful, your user name is displayed and the logout button is displayed.

To change the user, press the logout button.

If Wi-Fi setup has not been performed, the screen changes to the Wi-Fi setup screen after you press the login button.

When the setup is complete, log in.

- 10** Press the [Menu] button.

Setting finishes.

Uploading

There are three ways to upload log data.

- Data selection (upload manually)

- Differential upload (upload all log data that is different from the already uploaded log data)
- Auto upload (uploaded automatically)

After setting up Wi-Fi, perform either "[Uploading the log data manually](#)" or "[Uploading the log data automatically](#)."

[Wi-Fi Settings](#)

Uploading the log data manually

Select the log data to upload to Cyclo-Sphere from the list of log data and then upload the log data.

- 1 Press the [Menu] button.**
- 2 Use the [←]/[→] buttons to select [Settings] and then press the [Confirm] button.**

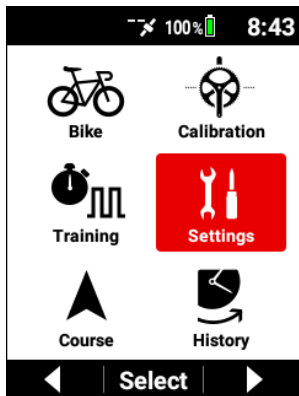

- 3** Use the [←]/[→] buttons to select [Cyclo-Sphere] and then press the [Confirm] button.

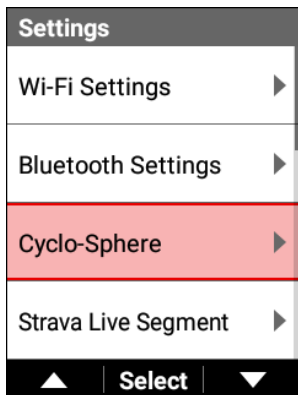

- 4** Use the [←]/[→] buttons to select [Manual Upload] and then press the [Confirm] button.

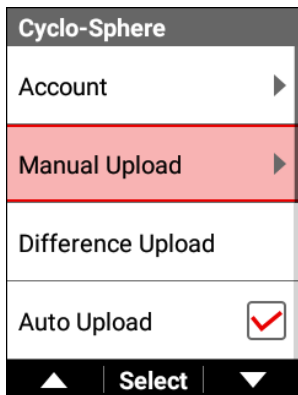

- 5** Use the [←]/[→] buttons to select the log data you wish to upload and then press the [Confirm] button.

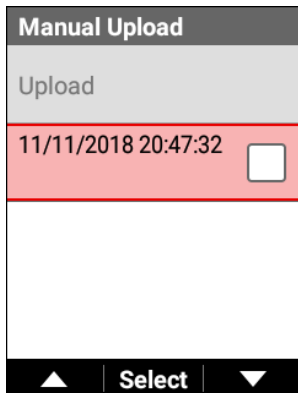

Repeat step 5 to add check marks for all the log data you wish to upload.

- 6** Use the [←]/[→] buttons to select [Upload] and then press the [Confirm] button.

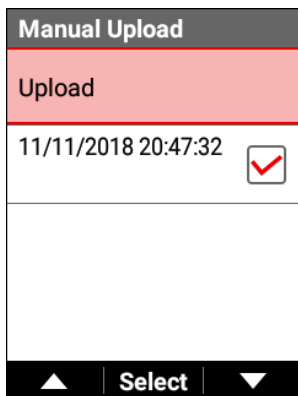

A connection is established via Wi-Fi automatically and uploading starts. When uploading is complete, the Wi-Fi connection is disconnected. "Wi-Fi" is displayed for log data that has been uploaded.

Note

- If you transfer log data to your iPhone or Android device when uploading log data via the Cyclo-Sphere Control App, "Bluetooth" is displayed.
- Both "Wi-Fi" and "Bluetooth" may be displayed.

Uploading only the log data that is different from the already uploaded log data

Upload all log data that has not been uploaded to Cyclo-Sphere.

- 1 Press the [Menu] button.**
- 2 Use the [←]/[→] buttons to select [Settings] and then press the [Confirm] button.**

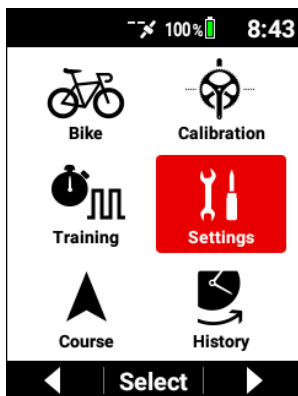

- 3** Use the [←]/[→] buttons to select [Cyclo-Sphere] and then press the [Confirm] button.

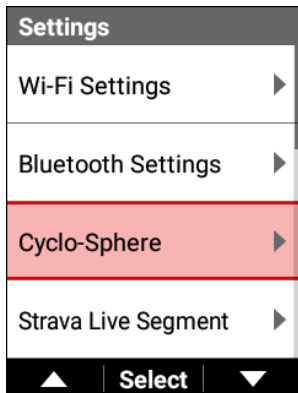

- 4** Use the [←]/[→] buttons to select [Difference Upload] and then press the [Confirm] button.

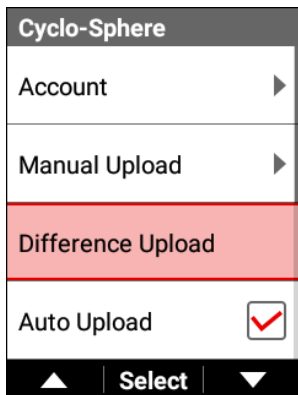

A connection is established via Wi-Fi automatically and uploading starts. When uploading is complete, the Wi-Fi connection is disconnected.

Uploading the log data automatically

The device can automatically establish a Wi-Fi connection and upload the log data to Cyclo-Sphere when logging stops and the log data is saved.

If there is log data that has not been uploaded to Cyclo-Sphere before logging starts or after the log data is saved, the device periodically checks for a Wi-Fi connection, and if a connection can be established, it uploads the log data to Cyclo-Sphere in the background.

- 1 Press the [Menu] button.**
- 2 Use the [←]/[→] buttons to select [Settings] and then press the [Confirm] button.**

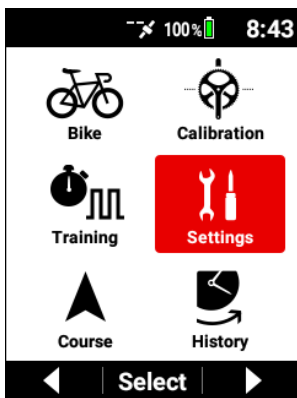

- 3** Use the [←]/[→] buttons to select [Cyclo-Sphere] and then press the [Confirm] button.

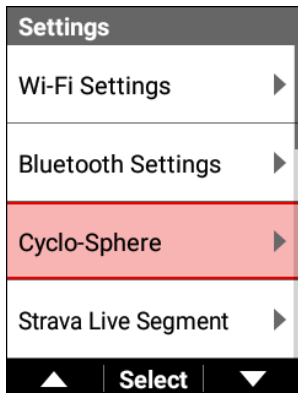

- 4** Use the [←]/[→] buttons to select [Auto Upload] and then press the [Confirm] button.

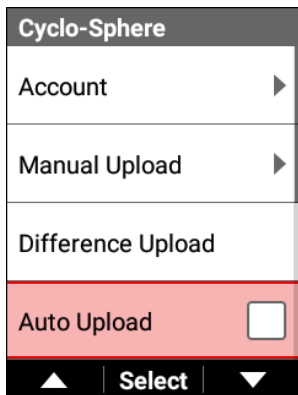

The check box is selected and auto upload is enabled.

■ Uploading Using a PC

Creating a Cyclo-Sphere account

Register from the following URL.
cyclo-sphere.com

Uploading

There is the following way to upload log data using a PC.

Note

- When uploading with the Cyclo-Sphere upload button, we recommend backing up your log data to a PC. Perform the upload after performing the operation described in “Backing up log data to a PC.”

Backing up log data to a PC

Transfer the log data in the built-in flash memory of the device to your PC.

- 1 Turn on the device and connect the device to your PC with the provided USB cable after the device has started up completely.**

The device is recognized as an MTP device on the PC.

The mode will be charging mode if you connect the USB cable while the power of the device is off.

For details on connecting the device and PC, refer to "[Charging the device.](#)"

Note

- For MTP connection with Macintosh, please refer to the following URL for example.
<https://www.android.com/filetransfer/>

- 2 Select the log data you wish to back up and save it in any location on the PC.**

The log data is stored in the "/CA600/Internal storage/Pioneer/Log" folder.

The file name of the log data is the date and hour that the log started.

Example: LOG_2019_01_01_08_20.db

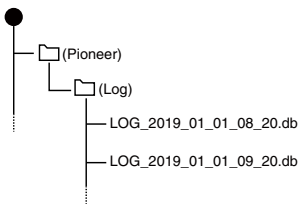

Uploading with the Cyclo-Sphere upload button

- 1 Log in to Cyclo-Sphere and then press the "Upload" button at the top of the workout screen.**

An upload pop-up appears.

- 2 Press the [ファイル選択] button in the pop-up and then select the file name to upload.**

The selected file name appears in the pop-up.

- 3 Press the [Upload] button.**

Analysis of the log data starts. (Analysis may take a while due to server congestion.)

You can check the analysis state if you leave the pop-up displayed. If you closed the pop-up, the analysis state is displayed at the top right of the workout list window.

You can check the progress by placing the mouse over it.

When the indication at the top right disappears, analysis is complete and the data has been added to the workout list.

For details, refer to the following website.

→ [https://cyclo-sphere.com/help/howtouse/help_howtouse_menuabar_upload](https://cyclo-sphere.com/help/howtouse/help_howtouse_menuubar_upload)

■ Uploading via Cyclo-Sphere Control App

Creating a Cyclo-Sphere account

Register from the following URL.

cyclo-sphere.com

Uploading

- 1 Install the Cyclo-Sphere Control App on your iPhone or Android device.**

<https://cyclo-sphere.com/app/>

- 2 Link the Cyclo-Sphere Control App and your device.**

Operate the Cyclo-Sphere Control App to display your device from [Add a new device] and then configure the link setting.

- 3 Select the following in order in the Cyclo-Sphere Control App.**

[SGX-CA600] > [Log Data upload settings]

- 4 Tap [Upload via smartphone] in the Cyclo-Sphere Control App.**

- 5 Check that authentication is complete for [Cyclo-Sphere Account Setting] in the Cyclo-Sphere Control App.**

If authentication is not complete, configure the account settings.

Note

- If there is log data that has not been transferred via Wi-Fi before the start of logging or after the saving of log data while the device and Cyclo-Sphere Control App are linked, the log data is transferred to the Cyclo-Sphere Control App via Bluetooth automatically.
- Transferred log data is transferred from the Cyclo-Sphere Control App to Cyclo-Sphere automatically using the phone line or Wi-Fi connection.
- To turn off automatic transfer from the Cyclo-Sphere Control App using the phone line in order to limit transfer to when there is a Wi-Fi connection, turn on the following setting.
[Others] > [Cyclo-Sphere Control Setting] > [Limit data communication such as file transmission via Wi-Fi.]
- Automatic transfer to Cyclo-Sphere may not be possible depending on the line connection status of the smartphone.
- It takes approximately 3 minutes per MB when transferring from the device to the Cyclo-Sphere Control App.
When there is about 5 hours of log data, it will take approximately 15 minutes for transfer to complete.

- If the device establishes a Wi-Fi connection while transferring log data from the device to the Cyclo-Sphere Control App, the log data will begin to be transferred via Wi-Fi if the auto upload function is enabled.
- If log data was uploaded via the Cyclo-Sphere Control App, "Bluetooth" is displayed below the log data name on the log data selection screen.
- If log data was uploaded via Wi-Fi, "Wi-Fi" is displayed below the log data name on the log data selection screen.
- Both "Wi-Fi" and "Bluetooth" may be displayed.

Training

Training Overview

The goals for road bike training differ depending on the person.

You can more objectively monitor and analyze your rides if you use a cyclocomputer for your regular training because a cyclocomputer is an effective training aid.



■ Clarifying the Areas You Wish to Strengthen

Riders who wish to enjoy cycling and long rides

For those who have just begun riding a road bike, the most important goal is to first ride at a constant speed so that you can get used to riding your road bike.

Have you ever thought the following during regular cycling?

- Both riding alone and riding with other people are fun, but riding with other people is more tiring than I expected and I do not want to be a burden on other people.
- I normally ride hard but there are situations where I can not keep up with other people. I want to get faster.

The best thing to do is to plan training that will help you overcome these issues.

Riders who wish to do well in road races

The key is to clarify the areas you wish to strengthen in consideration of the races you participate in, establish your goals, and then create a training menu.

Training that simply punishes your body will not necessary make you faster.

If anything, training that is too hard may have the opposite effect.

When you select training methods suitable for the areas you wish to strengthen, it is important to objectively monitor and analyze your rides.

Have you ever thought the following during regular training?

- I train according to a plan created to meet my goal, but I cannot seem to achieve my target placement.
- I am often disappointed because I cannot get the desired result and demonstrate my ability in competitions due to insufficient preparation.

The best thing to do is to plan training that will help you overcome these issues.

■ Types of Training Menus

Basically, you can use the following five methods to handle your training menus on the device.

Link menu

Send a training menu (workout) created in the TrainingPeaks service using the Cyclo-Sphere Control App on your iPhone or Android device, and import and link it on your device.

TRAININGPEAKS™



Training assistance

You can use the Wi-Fi function of the device to download the training menus you created using the Cyclo-Sphere Analysis App or the smartphone version of the Cyclo-Sphere website.



Original menu

This is a simple training menu that can be created and edited on the device.

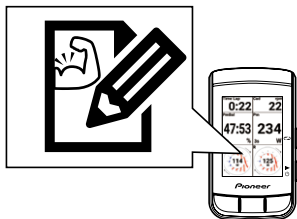

FTP 20-minute test

This is a training menu in which you ride for 20 minutes and measure your functional threshold power (FTP).

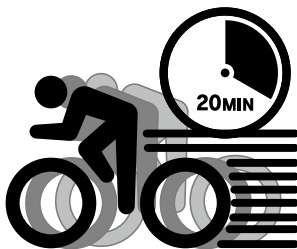

MMP challenge

This is a training menu based on your mean maximal power (MMP) data.

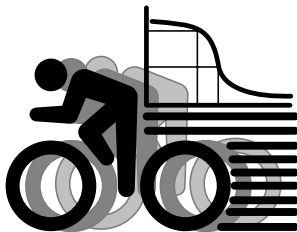

You can customize the target FTP and target power for the FTP 20-minute test and MMP challenge training menus.

■ Laps

Training to ride at an average speed and training to gain explosive sprint power work on different areas and thus require different training methods.

Even within one training menu, there is a separator for every time spent, for example, warming up, riding focusing on cadence, riding focusing on pedaling, and cooling down, and these separators are called "laps."

Furthermore, the segment between one separator and another is called an "interval."

A lap is used for the separator between training, and for the separator of intervals within training.

A lap is the end point of the previous interval, as well as the start point of the next interval.

Accurate analysis of each interval segment can be performed later by correctly separating the collected data by lap.



If not separated by lap...

Data that has been averaged overall is collected so analysis cannot be performed properly later.

It is difficult to know during training from where the ride method needs to be changed.

■ Laying out an Appropriate Display for a Lap

The device allows you to select which numerical values to show on the display. This enables arbitrarily setting the value you wish to monitor the most during that training, as well as the other values you think are important.

For details, refer to "[Setting Data Fields](#)."

■ Auto Lap Function

The Auto Lap function operates only during logging. It does not operate when logging is stopped, during auto pause, and while a training menu is in progress.

For details, refer to "[Auto Lap Settings](#)"

Using Training Assistance

A training menu created using the training assistance of the Cyclo-Sphere Analysis App (for iPhone) can be imported into the device.

You can also use the training assistance from the smartphone version of the Cyclo-Sphere website by using an iPhone or Android device.

The procedure is roughly as follows.

■ **Creating a Training Menu of Training Assistance**

- Create a training menu in the Cyclo-Sphere Analysis App.
- Create a training menu using the smartphone version of the Cyclo-Sphere website.

■ **Downloading the Training Menu of Training Assistance**

- Download the training menu via Wi-Fi using the device.

■ **Creating a Training Menu**

This section describes how to create a training menu using the training assistance of the Cyclo-Sphere Analysis App (for iPhone).

For a training menu created using training assistance, the laps are added automatically to the appropriate positions, and the page settings are switched automatically to the layout recommended for the training details.

This saves you the trouble of having to manually press laps and select pages.

(You can also manually operate laps and change pages.)

Cyclo-Sphere Analysis App comes with 28 types of training menus. The following describes an example of creating "B7: Interval Training Using a Power Meter".

1 Install the Cyclo-Sphere Analysis App (for iPhone).

If this your first time to use Cyclo-Sphere, register as a user and create an account.

2 Log in to the Cyclo-Sphere Analysis App (for iPhone).

3 Tap [More] > [Training Assist].

After a while, a list of the training menus of the training assistance appears.

4 Tap [Power Training] > [B7: Interval Training Using a Power Meter].

After a while, an explanation of the details of this training appears.

5 Carefully read the details and then tap [Training Menu].

An explanation of the training menu is displayed, and the parameters required when creating the training menu are displayed.

- 6 Set the necessary parameters and tap [Training Menu Creation].

A message appears to notify you that the training menu has been created.

- 7 Tap [OK].

■ Connecting the Device via Wi-Fi

For how to connect the device via Wi-Fi, refer to the following.

[Wi-Fi Settings](#)

■ Importing a Training Menu

This section describes how to import a training menu created in the Cyclo-Sphere Analysis App to the device so that you can display it as a training menu on the device.

Note

- Configure the account settings in advance.
[Creating a Cyclo-Sphere account](#)

- 1 Press the [Menu] button.
- 2 Use the [←]/[→] buttons to select [Settings] and then press the [Confirm] button.

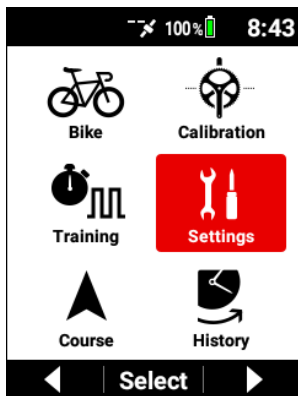

- 3 Use the [←]/[→] buttons to select [Cyclo-Sphere] and then press the [Confirm] button.

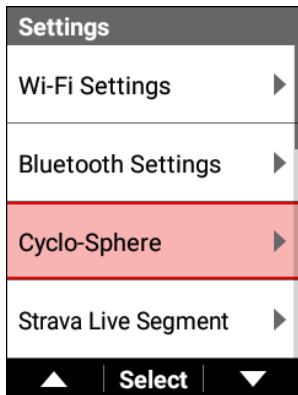

- 4 Check that the check box is selected for [Training Menu Sync].

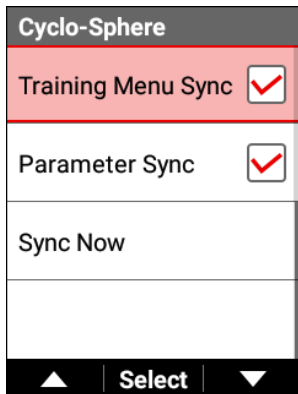

If the check box is not selected, use the [←]/[→] buttons to select [Training Menu Sync] and then press the [Confirm] button.

- 5 Use the [←]/[→] buttons to select [Sync Now] and then press the [Confirm] button.**

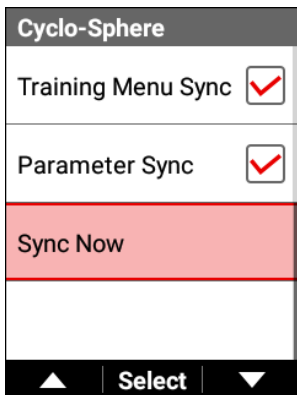

Wait until the synchronization finishes.

- 6 When the synchronization finishes, press the [Menu] button to return to the main menu screen.**

■ Selecting an Imported Training Menu

- 1 Press the [Menu] button.**

- 2 Use the [←]/[→] buttons to select [Training] and then press the [Confirm] button.



- 3 Use the [←]/[→] buttons to select [Training Menu] and then press the [Confirm] button.

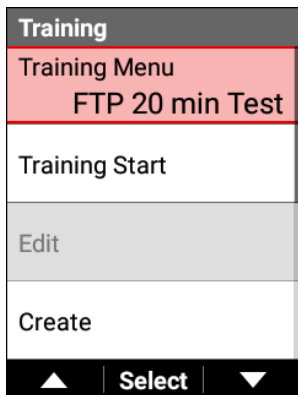

The name of the currently selected training menu is displayed in the [Training Menu] item.

- 4 Use the [←]/[→] buttons to select [Training Assist] and then press the [Confirm] button.

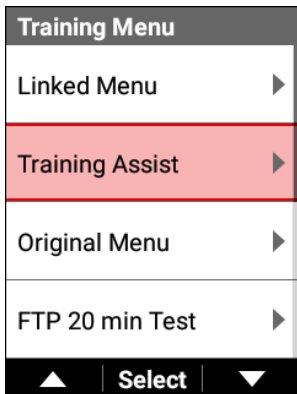

- 5 Use the [←]/[→] buttons to select the training item you wish to use and then press the [Confirm] button.

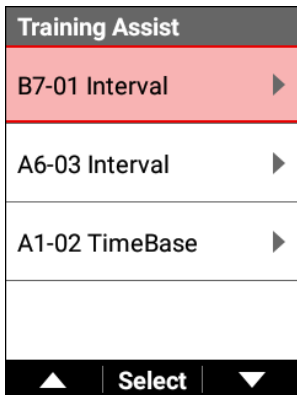

- 6** Check the training details and then press the [Confirm] button.

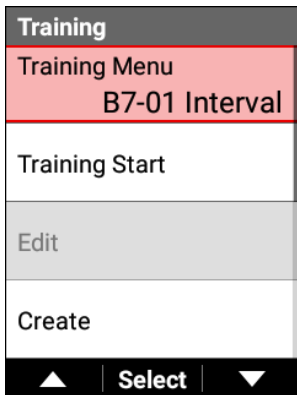
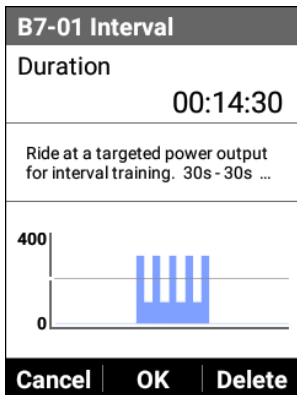

The name of the selected training menu is displayed in the [Training Menu] item.

Starting/Ending a Training Menu

- 1 Press the [Menu] button.
- 2 Use the [←]/[→] buttons to select [Training] and then press the [Confirm] button.



- 3** Use the [←]/[→] buttons to select [Training Start] and then press the [Confirm] button.

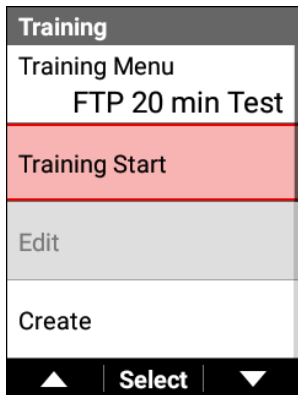

The training menu start message appears.

If you press the [Confirm] button, the meter screen reappears and the training menu starts.

Start training in accordance with the instructions on the screen.

Note

- If logging is already started, the training menu will be separated by laps and the first interval segment will start.
If logging is not started, logging will start simultaneously with the start of the training menu.
- If you press the [Logging] button, the training menu pauses.
Press the [Logging] button again to resume the training menu.

- 4** Start training in accordance with the instructions on the screen.

The instructions for the first interval segment are displayed. When it becomes time for the next interval segment, the instructions for that segment are displayed.

This process is repeated. When all of the interval segments are finished, the training menu ends automatically and the finished message appears on the screen.

Note

- Pressing the [Lap] button skips to the next the training menu. If the training menu is separated by laps, the next interval segment will start.

5 Press the [Logging] button.

Logging stops and the save confirmation message appears.

If you press the [Confirm] button, the log data is saved and the screen displayed before you started logging reappears.

If you press the [←] button, the message closes and the previous screen reappears while logging remains in the stopped state. When you wish to restart logging, press the [Logging] button again.

If you press the [→] button, the log data deletion confirmation message appears.

If you press the [Confirm] button, the log data is deleted and the screen displayed before you started logging reappears.

Note

- You can also save the log data by pressing and holding the [Lap] button for 2 seconds or more in the logging stopped state.
- When the capture function is enabled, the function to save the logging data by pressing and holding the [Lap] button while logging is stopped will not work.
- Auto Lap does not operate while a training menu is in progress.
- If a different training menu is selected while a training menu is in progress, the training menu set before the selection ends and the newly set training menu is selected.

■ Forcibly Ending a Training Menu Part Way Through

You can forcibly end a training menu part way through.

1 Press the [Menu] button.

- 2 Use the [←]/[→] buttons to select [Training] and then press the [Confirm] button.



- 3 Use the [←]/[→] buttons to select [Training Stop] and then press the [Confirm] button.

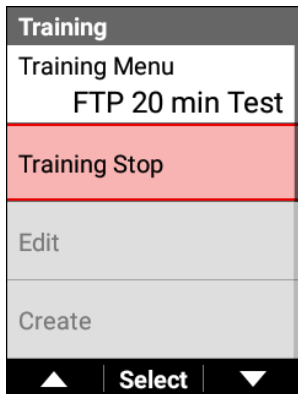

Note

- Since the log data will continue to be acquired even after the training menu ends, press the [Logging] button to stop logging and then check the save confirmation message and save the log data.

■ Deleting a Training Menu

You can delete a training menu that was imported to the device or a training menu that was created on the device.

Note

- You can delete only the training menus that were created from [Linked Menu], [Training Assist], and [Original Menu].

- 1** Press the [Menu] button.
- 2** Use the [←]/[→] buttons to select [Training] and then press the [Confirm] button.



- 3** Use the [←]/[→] buttons to select [Training Menu] and then press the [Confirm] button.



- 4** Use the [←]/[→] buttons to select the training item you wish to delete and then press the [Confirm] button.



Refer to "[Selecting an Imported Training Menu](#)" and then select the training menu you wish to delete.

- 5 Check that the training menu you wish to delete is displayed and then press the [→] button.

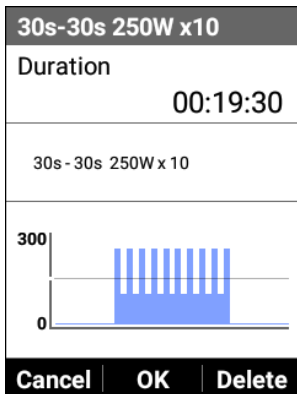

- 6 Press the [Confirm] button.

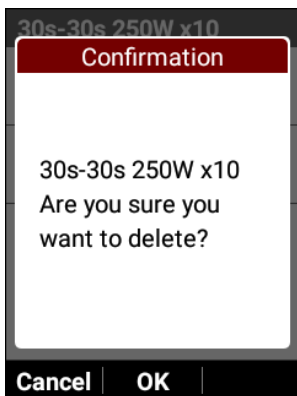

The training menu is deleted.

Using a Link Menu

You can transfer a training menu (workout) created using TrainingPeaks to the device via the Cyclo-Sphere Control App.

1 Create an account for TrainingPeaks and then create a training menu.

Preparation requires creating an account on the TrainingPeaks website or in the TrainingPeaks App.

For details, refer to the TrainingPeaks website.

<https://www.trainingpeaks.com/>

2 Install the Cyclo-Sphere Control App on your iPhone or Android device.

3 Link the Cyclo-Sphere Control App and your device.

Operate the Cyclo-Sphere Control App to display your device from [Add a new device] and then configure the link setting.

4 Select the following in order in the Cyclo-Sphere Control App.

[Others] > [Cooperation with other services]

5 Tap [Training Peaks Authentication] in the Cyclo-Sphere Control App.

The authentication screen of TrainingPeaks appears.

6 Perform authentication in accordance with the instructions on the screen in the Cyclo-Sphere Control App.

When authentication for TrainingPeaks completes in the Cyclo-Sphere Control App, the [Get training menu] option becomes selectable.

7 Check that the [Get training menu] option in the Cyclo-Sphere Control App is on.

8 Press the [Menu] button.

- 9 Use the [←]/[→] buttons to select [Training] and then press the [Confirm] button.



- 10 Use the [←]/[→] buttons to select [Training Menu] and then press the [Confirm] button.

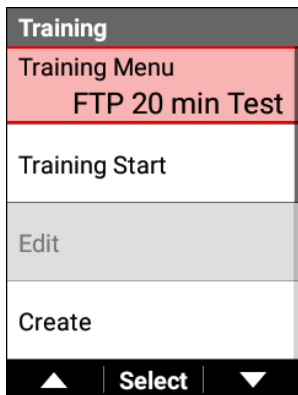

The name of the currently selected training menu is displayed in the [Training Menu] item.

- 11** Use the [←]/[→] buttons to select [Linked Menu] and then press the [Confirm] button.

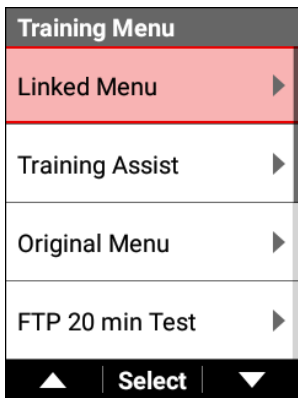

- 12** Use the [←]/[→] buttons to select the training item you wish to use and then press the [Confirm] button.

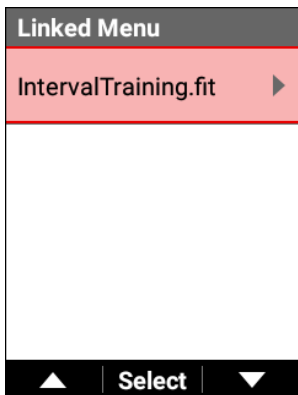

- 13** Check the training details and then press the [Confirm] button.

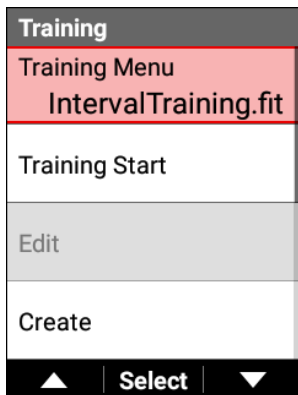
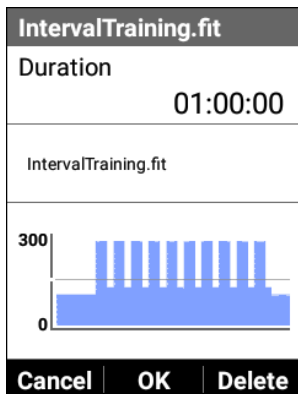

The name of the selected training menu is displayed in the [Training Menu] item.

Note

- If you press the [←] button, the operation is canceled and the previous screen reappears without the displayed training menu being selected.

Using an Original Menu

You can create a training menu with operation only on the device, and then use it for training.

There is the method of selecting from three original menus provided on the device in advance, the method of editing a selected original menu to match your preferences, and the method of creating a new original menu.

■ Selecting an Original Menu

- 1** Press the [Menu] button.
- 2** Use the [←]/[→] buttons to select [Training] and then press the [Confirm] button.



- 3** Use the [←]/[→] buttons to select [Training Menu] and then press the [Confirm] button.



- 4** Use the [←]/[→] buttons to select [Original Menu] and then press the [Confirm] button.

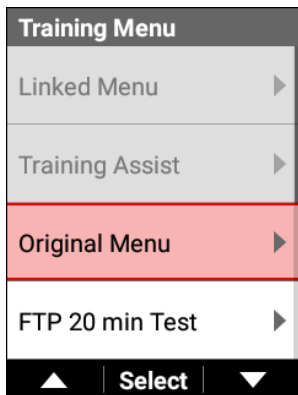

- 5** Use the [←]/[→] buttons to select a menu and then press the [Confirm] button.

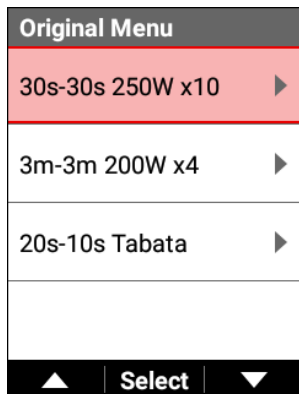

- 6** Press the [Confirm] button.

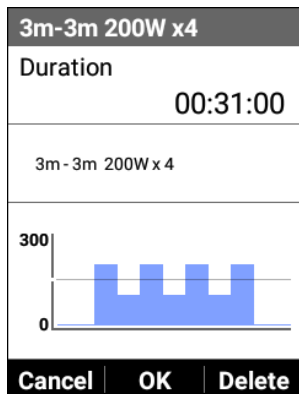

The selected original menu is set as the training menu, and the screen of step 3 reappears.

■ Editing an Original Menu

- 1 Press the [Menu] button.
- 2 Use the [←]/[→] buttons to select [Training] and then press the [Confirm] button.



- 3** Use the [←]/[→] buttons to select [Edit] and then press the [Confirm] button.

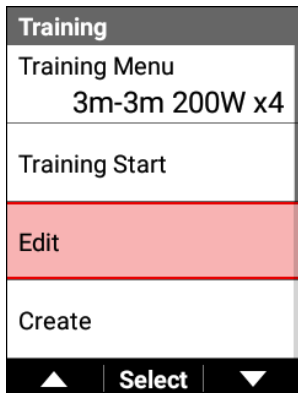

Check that the name of an original menu is displayed in [Training Menu].

- 4** Use the [←]/[→] buttons to select each item and then press the [Confirm] button.

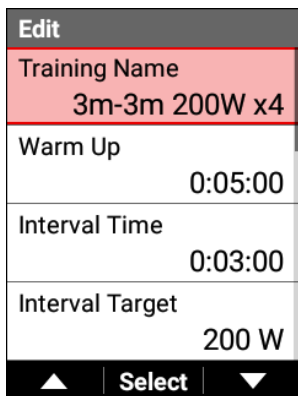

- 5** Use the [←]/[→] buttons to select [Save] or [Add New], and then press the [Confirm] button.

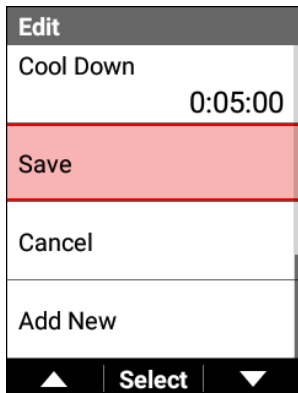

The edited training menu is saved or copied to the cyclocomputer and set as the training menu to use.

Note

- If you select [Add New], "_copy" is automatically added to the end of the menu name.

■ Creating an Original Menu

- 1** Press the [Menu] button.

- 2 Use the [←]/[→] buttons to select [Training] and then press the [Confirm] button.



- 3 Use the [←]/[→] buttons to select [Create] and then press the [Confirm] button.

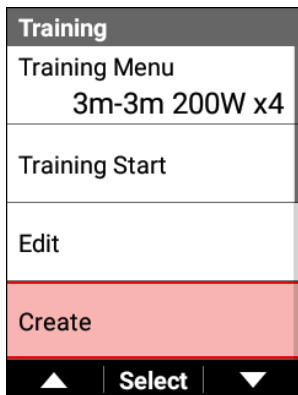

- 4 Use the [←]/[→] buttons to select each item and then press the [Confirm] button.

Create	
Training Name	Interval_1
Warm Up	0:05:00
Interval Time	0:00:30
Interval Target	200 W

▲ | Select | ▼

Setting item details

- 5 Use the [←]/[→] buttons to select [Save] and then press the [Confirm] button.

Create	
Cool Down	0:05:00
Save	
Cancel	

▲ | Select | ▼

The created training menu is saved to the device and set as the training menu to use.

Setting item details

Setting item	Description
Training Name	Enter the name of this training menu.
Warm Up	Set the warm-up time.
Interval Time	Set the time for performing an interval after the warm-up.
Interval Target	Set the target power value (target output value) for performing an interval.
Escalation	Set an escalation value when you want a training menu for which the target power value of the next interval is higher than that of the previous interval. (For example, if you wish the interval power to be 200 W in interval segment 1, and then to increase by 5 W for every next interval segment after that, set this to 5 W.)
Rest Time	Set the time for taking a rest between the previous interval and next interval.
Rest Target	Set the target power value (target output value) for taking a rest.
Interval Set	Set the number of interval segments to include. If the number of intervals is set to only 1, the settings of [Rest Time] and [Rest Target] will be disabled because there will no longer be a rest.
Cool Down	Set the cool down time.

Measuring Your FTP

Ride for 20 minutes to measure the output you can maintain for one hour (FTP <Functional Threshold Power>).

This device sets a power value of 95% of the measurement result as your current FTP.

Note

- The value set in [Settings] > [User Settings] > [FTP] or the value of the analysis result of Cyclo-Sphere is set as the initial value for the FTP.

FTP 20-minute test training menu figure

FTP (20 min)

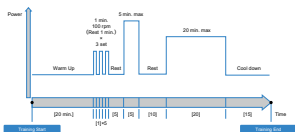

- 1 Press the [Menu] button.
- 2 Use the [←]/[→] buttons to select [Training] and then press the [Confirm] button.



- 3** Use the [←]/[→] buttons to select [Training Menu] and then press the [Confirm] button.



The name of the currently selected training menu is displayed in the [Training Menu] item.

- 4** Use the [←]/[→] buttons to select [FTP 20 min Test] and then press the [Confirm] button.

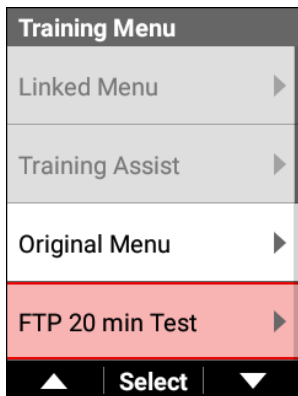

- 5 Use the [←]/[→] buttons to select [Target FTP] and then press the [Confirm] button.

FTP 20 min Test	
Current FTP	230 W
Target FTP	234 W
Target Power	246 W
Set	

▲ | Select | ▼

- 6 Use the [←]/[→] buttons to enter the target FTP value and then press the [Confirm] button.

Adjust the target FTP value as necessary.

Target FTP	
0	2 3 4
	W

– | Next | +

- 7** Use the [←]/[→] buttons to select [Set] and then press the [Confirm] button.

FTP 20 min Test	
Current FTP	230 W
Target FTP	234 W
Target Power	246 W
Set	
▲	Select ▼

"FTP 20 min Test" is displayed for the [Training Menu] item.

Note

- A numerical value that is approximately 5% higher than the target FTP becomes the target power.

- 8 Use the [←]/[→] buttons to select [Training Start] and then press the [Confirm] button.

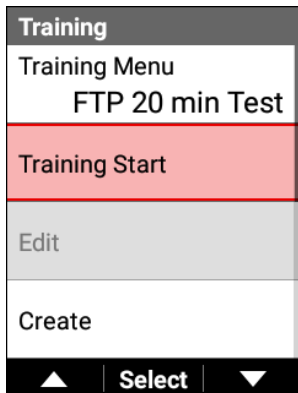

- 9 Press the [Confirm] button.



The warm-up starts.

The instructions for the first interval segment are displayed. When it becomes time for the next interval segment, the instructions for that segment are displayed.

This process is repeated. When all of the interval segments are finished, the training menu ends automatically and the finished message appears on the screen.

Note

- If you press the [Lap] button, the next interval segment will start.

10 Press the [Logging] button.

Logging stops and the save confirmation message appears.

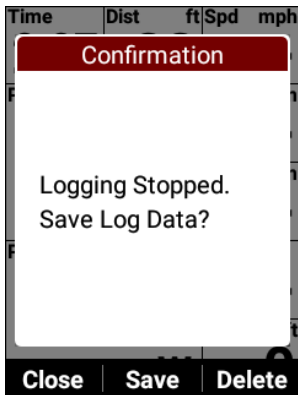

If you press the [Confirm] button, the log data is saved and the "Update your FTP data?" message appears.

If you press the [Confirm] button, the FTP value in the user settings is updated with the new FTP measurement result.

If multiple FTP measurement results are recorded in the log data, you can select the measurement result by pressing the [→] button.

If you press the [←] button, the message closes and the previous screen reappears while logging remains in the stopped state.

Updating the FTP measurement result in the user settings will result in a message being displayed when the log data is saved.

When you wish to restart logging, press the [Logging] button again.

If you press the [→] button, the log data deletion confirmation message appears.

If you press the [Confirm] button, the log data is deleted and the screen displayed before you started logging reappears (the FTP value is not updated).

Note

- You can also save the log data by pressing and holding the [Lap] button for 2 seconds or more when in the logging stopped state.
- When the capture function is enabled, the function to save the logging data by pressing and holding the [Lap] button while logging is stopped will not work.
- When [Parameter Sync] is enabled and [Auto Upload] is enabled, or when you press the [Sync Now] button, the measurement result is uploaded to Cyclo-Sphere and the measurement date is updated.

Performing Training Based on Your MMP Data

Mean maximal power (MMP) is the maximum power that you can output on average for a given period of time.

For example, MMP includes data such as an average of 280 W for 5 minutes, which means that this is the maximum value within the arbitrary period (most recent month or year) for that data.

Performing training based on this MMP data allows you to perform training with updating the mean maximal power as your goal.

When you parameter synchronize the device with Cyclo-Sphere, the MMP data for the most recent three months is downloaded to the device.

■ Types of Threshold Training

There are the times of 1 minute, 3 minutes, 5 minutes, 10 minutes, 20 minutes, and 60 minutes, and you can perform training with the power value of 102% of the MMP for the selected time as your goal.

The MMP training of 60 minutes is the same as measuring your FTP value, so the measurement result can be reflected as the measurement result of your FTP.

MMP challenge training menu figure

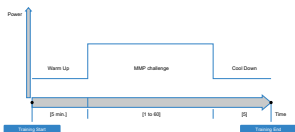

■ Setting the MMP

There are two ways to set MMP data.

- Synchronizing the MMP with Cyclo-Sphere
- Entering the MMP manually

Note

- When you synchronize the MMP with Cyclo-Sphere, there needs to be a certain amount of riding data in Cyclo-Sphere and it must contain MMP values.

Synchronizing the MMP with Cyclo-Sphere

- 1 Press the [Menu] button.
- 2 Use the [←]/[→] buttons to select [Settings] and then press the [Confirm] button.

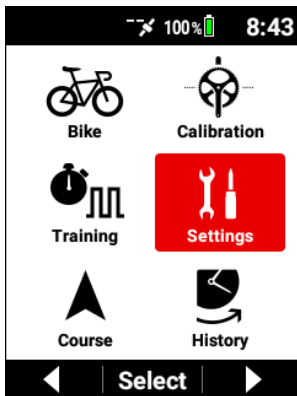

- 3 Use the [←]/[→] buttons to select [Cyclo-Sphere] and then press the [Confirm] button.

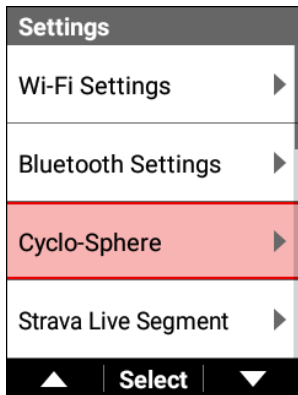

- 4 Check that the [Parameter Sync] check box is selected, use the [←]/[→] buttons to select [Sync Now], and then press the [Confirm] button.

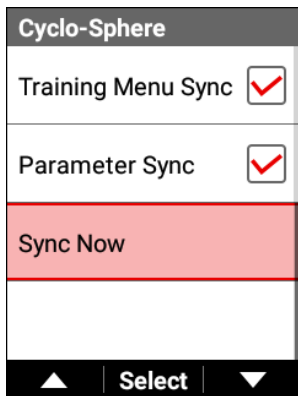

Wait until the synchronization finishes.

When the synchronization finishes, the MMP data for the most recent three months in Cyclo-Sphere is reflected on the device.

Entering the MMP manually

Manually set the MMP value required in the Threshold Training.

- 1 Press the [Menu] button.**
- 2 Use the [←]/[→] buttons to select [Settings] and then press the [Confirm] button.**

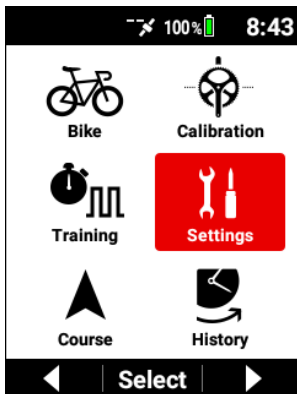

- 3 Use the [←]/[→] buttons to select [User Settings] and then press the [Confirm] button.

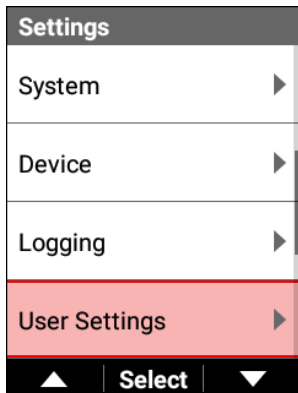

- 4 Use the [←]/[→] buttons to select [MMP] and then press the [Confirm] button.

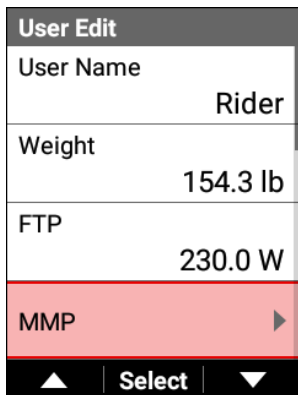

- 5 Use the [←]/[→] buttons to select the item to use for training and then press the [Confirm] button.

MMP	
10 sec MMP	800 W
30 sec MMP	560 W
1 min MMP	430 W
3 min MMP	300 W

▲ | Select | ▼

- 6 Use the [←]/[→] buttons to select the numerical value you wish to set and then press the [Confirm] button.

10 sec MMP

0	8	0	0
---	---	---	---

W

— | Next | +

Each press of the [Confirm] button moves the cursor to the next digit place down.

If you press the [Confirm] button after the cursor has been moved to the ones place, the numerical value is confirmed and the previous screen reappears.

7 Enter the other items in the same way as necessary.

You can also end input after entering only the item to be used in the Threshold Training.

Starting an Threshold Training

1 Press the [Menu] button.

2 Use the [←]/[→] buttons to select [Training] and then press the [Confirm] button.



3 Use the [←]/[→] buttons to select [Training Menu] and then press the [Confirm] button.

The name of the currently selected training menu is displayed in the [Training Menu] item.



- 4** Use the [←]/[→] buttons to select [Threshold Training] and then press the [Confirm] button.

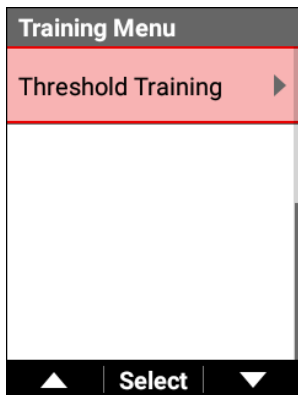

- 5 Use the [←]/[→] buttons to select [Challenge Menu] and then press the [Confirm] button.

Threshold Training	
Challenge Menu	1 min MMP
Current Record	430 W
Target Power	438 W
Set	

▲ | Select | ▼

- 6 Use the [←]/[→] buttons to select the item you wish to set and then press the [Confirm] button.

Challenge Menu	
1 min MMP	<input checked="" type="radio"/>
3 min MMP	<input type="radio"/>
5 min MMP	<input type="radio"/>
10 min MMP	<input type="radio"/>

▲ | Select | ▼

- 7** Use the [←]/[→] buttons to select [Target Power] and then press the [Confirm] button.

Threshold Training	
Challenge Menu	1 min MMP
Current Record	430 W
Target Power	438 W
Set	

▲ | Select | ▼

- 8** Use the [←]/[→] buttons to enter the target power you wish to set as a goal and then press the [Confirm] button.

Target Power			
0	4	3	8
W			

− | Next | +

Each press of the [Confirm] button moves the cursor to the next digit place down.

If you press the [Confirm] button after the cursor has been moved to the ones place, the numerical value is confirmed and the previous screen reappears.

Adjust the target power as necessary.

Note

- A numerical value that is approximately 2% higher than the MMP value displayed in the [Current Record] field becomes the target power.

- 9 Use the [←]/[→] buttons to select [Set] and then press the [Confirm] button.

Threshold Training	
Challenge Menu	1 min MMP
Current Record	430 W
Target Power	438 W
Set	
▲	Select ▼

The value selected in step 6 is displayed for the [Training Menu] item.

- 10** Use the [←]/[→] buttons to select [Training Start] and then press the [Confirm] button.

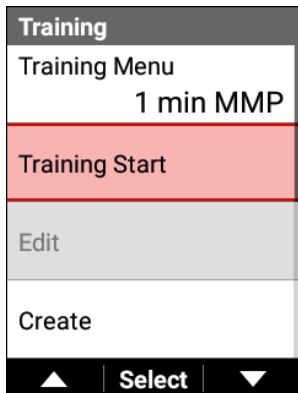

- 11** Press the [Confirm] button.

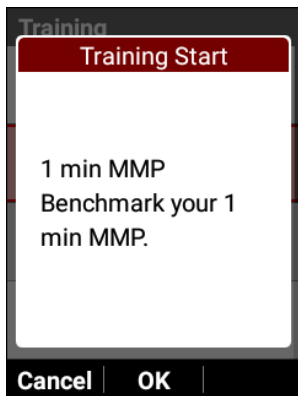

The warm-up starts.

The riding instructions for the first interval segment are displayed. When it becomes time for the next interval segment, the riding instructions for that segment are displayed.

This process is repeated. When all of the interval segments are finished, the training menu ends automatically and the finished message appears on the screen.

Note

- If you press the [Lap] button, the next interval segment will start.

12 Press the [Logging] button.

Logging stops and the save confirmation message appears.

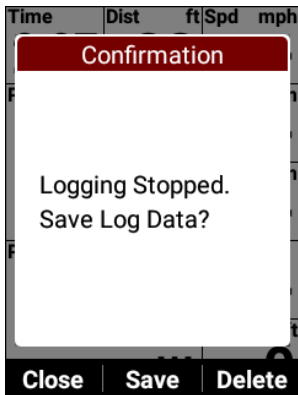

If you press the [Confirm] button, the log data is saved.

If you press the [←] button, the message closes and the previous screen reappears while logging remains in the stopped state.

When you wish to restart logging, press the [Logging] button again.

If you press the [→] button, the log data deletion confirmation message appears.

If you press the [Confirm] button, the log data is deleted and the screen displayed before you started logging reappears.

Note

- You can also save the log data by pressing and holding the [Lap] button for 2 seconds or more when in the logging stopped state.
- When the capture function is enabled, the function to save the logging data by pressing and holding the [Lap] button while logging is stopped will not work.

Automatically Switching to the Screen That Matches the Training Menu

If the [Auto Page Transition] check box is selected, the data field display will switch automatically to the layout recommended for the training menu when the training menu starts.

Note

- You can edit the data fields even when the layout is the recommended layout.

- 1** Press the [Menu] button.
- 2** Use the [←]/[→] buttons to select [Training] and then press the [Confirm] button.

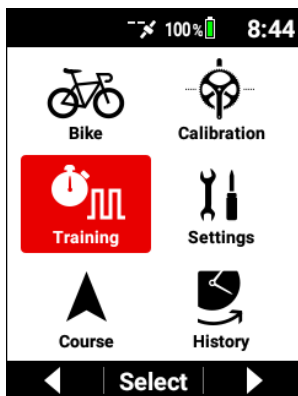

- 3 Use the [←]/[→] buttons to select [Auto Page Transition] and then press the [Confirm] button.

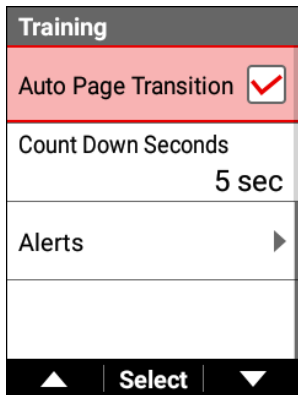

When the check box is selected, the Auto Page Transition function is enabled.

Setting the Countdown Timer

While a training menu is in progress, a countdown to the next interval is displayed to urge you to prepare for the next interval.

You can set the number of seconds for that countdown.

- 1 Press the [Menu] button.

- 2 Use the [←]/[→] buttons to select [Training] and then press the [Confirm] button.



- 3 Use the [←]/[→] buttons to select [Count Down Seconds] and then press the [Confirm] button.

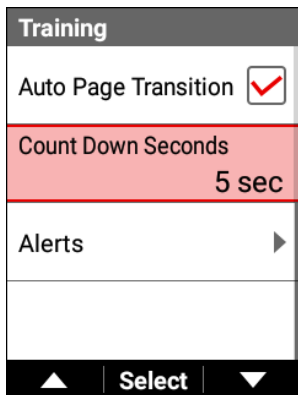

The countdown is performed with the selected number of seconds.

Select the countdown time from [3 sec], [5 sec]*. and [10 sec].

*: Factory default setting

Note

- If [10 sec] is selected and the current interval time is less than 10 sec, the countdown will be from an interval time of less than 10 sec.

Using the Alert Notification Function

This is a function to notify when the value goes above or below a set value during logging.

Note

- The alert function operates only during logging. It does not operate when logging is stopped.

Configuring the Basic Settings of Alerts

■ Setting the Message and Sound

Set whether or not to display a message and whether or not to output a sound for various alerts.

- 1** Press the [Menu] button.
- 2** Use the [←]/[→] buttons to select [Training] and then press the [Confirm] button.



- 3** Use the [←]/[→] buttons to select [Alerts] and then press the [Confirm] button.

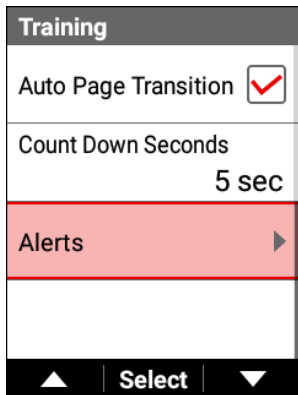

Setting item	Description
Message	Select this check box to display a message when there is a notification. Clear this check box to not display a message.
Sound	Select this check box to output a sound when there is a notification. Clear this check box to not output a sound.

■ Power, Heart Rate, and Cadence

Set the upper limit and lower limit for power, heart rate, and cadence. The following explains how to set the "Power Alert" as an example.

- 1** Press the [Menu] button.

- 2 Use the [←]/[→] buttons to select [Training] and then press the [Confirm] button.



- 3 Use the [←]/[→] buttons to select [Alerts] and then press the [Confirm] button.

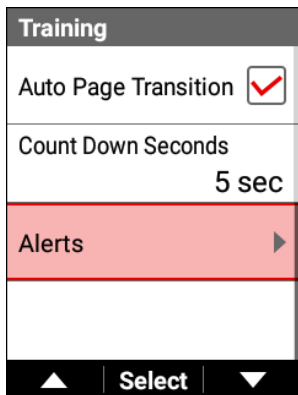

- 4 Use the [←]/[→] buttons to select [Power Alert] and then press the [Confirm] button.

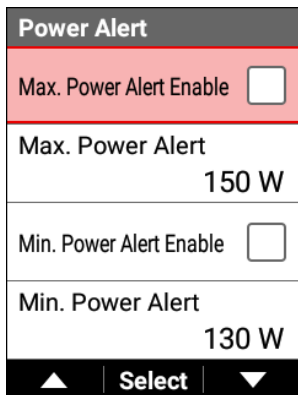
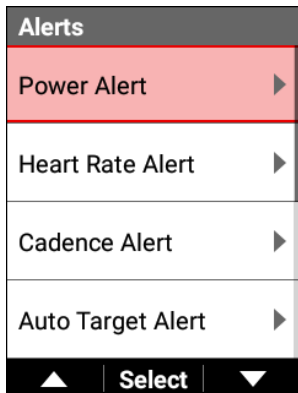

Setting item	Description
Max. Power Alert Enable	Select this check box to be notified when the power goes above the upper limit. Clear this check box to not be notified.
Max. Power Alert	When the power goes above the value set here, you will be notified with a power alert.
Min. Power Alert Enable	Select this check box to be notified when the power goes below the lower limit. Clear this check box to not be notified.
Min. Power Alert	When the power goes below the value set here, you will be notified with a power alert.

Note

- If two or more types go outside the ranges at the same time, you only receive the alert for one type with the priority given in the order of power, heart rate, and cadence.

5 Press the [Menu] button.

6 Set each item of [Heart Rate Alert] and [Cadence Alert].

Using the Auto Target Alert Function

When a training menu is in progress, this function alerts you when the power, heart rate, or cadence goes outside the range specified for the target power, target heart rate, or target cadence of that training menu.

Note

- The items for which to alert are set automatically depending on the training menu.

1 Press the [Menu] button.

- 2 Use the [←]/[→] buttons to select [Training] and then press the [Confirm] button.



- 3 Use the [←]/[→] buttons to select [Alerts] and then press the [Confirm] button.

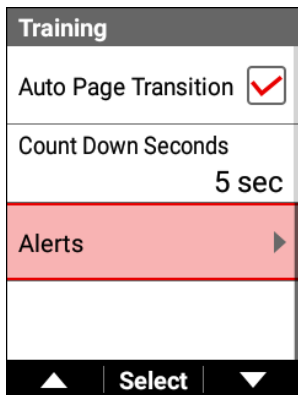

- 4 Use the [←]/[→] buttons to select [Auto Target Alert] and then press the [Confirm] button.

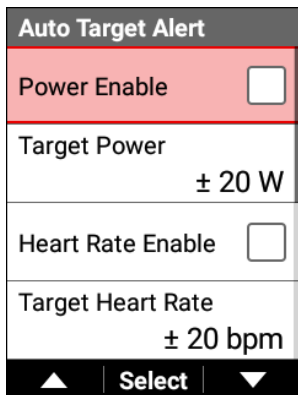
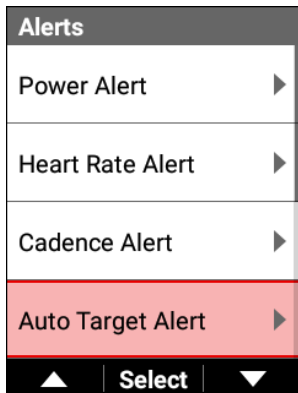

Setting item	Description
Power	Select this check box to enable alerts. Clear this check box to not be notified.

Target Power	When the power goes above or below the range set here with respect to the value set for the target power of the corresponding training menu, you will be notified.
Heart Rate	Select this check box to enable alerts. Clear this check box to not be notified.
Target Heart Rate	When the heart rate goes above or below the range set here with respect to the value set for the target heart rate of the corresponding training menu, you will be notified.
Cadence	Select this check box to enable alerts. Clear this check box to not be notified.
Target Cadence	When the cadence goes above or below the range set here with respect to the value set for the target cadence of the corresponding training menu, you will be notified.

Note

- If two or more types go outside the ranges at exactly the same time, you only receive the alert for one type with the priority given in the order of power, heart rate, and cadence.

Using the Intensity Alert Function

This function calculates your intensity in real time and alerts you when it exceeds the specified threshold value.

It calculates the ratio of multiple mean power values to the MMP curve in real time and determines the highest value as your current training intensity.

- 1 Press the [Menu] button.**

- 2 Use the [←]/[→] buttons to select [Training] and then press the [Confirm] button.



- 3 Use the [←]/[→] buttons to select [Alerts] and then press the [Confirm] button.

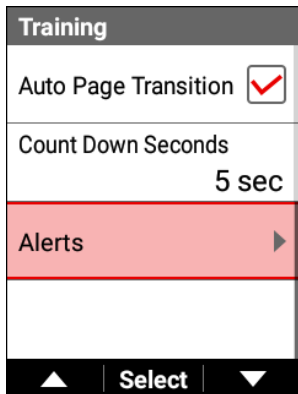

- 4 Use the [←]/[→] buttons to select [Intensity Alert] and then press the [Confirm] button.

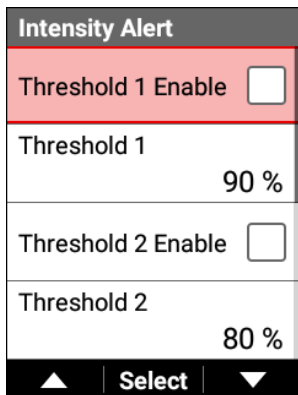
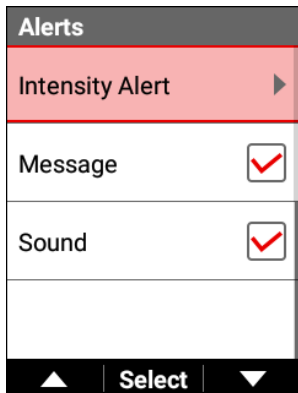

Setting item	Description
Threshold1 Enable, Threshold2 Enable, Threshold3 Enable	Select a check box to enable the corresponding threshold value. Clear this check box to not be notified.
Threshold1, Threshold2, Threshold3	Notify when the intensity exceeds the values set here.

Using the Strava Live Segment Function

About Strava Live Segment

The Live Segment function allows you to automatically transfer a segment that you or others have created in Strava to the device using the Cyclo-Sphere Control App allowing you to compare your current ride with yours or others past results, logging begins when you enter the transferred segment. Strava Live Segments are useful for improving your riding skills and segment placement by viewing pace and time differences.

Furthermore, your activity at this time is also reflected as Strava data so you can also review your ride later.

For details on Strava, refer to the following URL.

<https://www.strava.com/features>

Transferring a Strava Live Segment

Note

- To use the Strava Live Segment function, you need to register for a paid account (Summit) in Strava.
- You need to register the segments you wish to transfer as favorite segments in Strava.

- 1** Install the Cyclo-Sphere Control App on your iPhone or Android device.
- 2** Select the following in order in the Cyclo-Sphere Control App.
[Others] > [Cooperation with other services]
- 3** Tap [Strava Authentication] in the Cyclo-Sphere Control App.
The authentication screen of Strava appears.

4 Perform authentication in accordance with the instructions on the screen in the Cyclo-Sphere Control App.

When Strava authentication is completed with "Cyclo-Sphere Control App", the segments registered as favorites in Strava are automatically transferred to the device.

The segments that have been automatically transferred can be checked in [Menu] - [Settings] - [Strava Live Segment] - [Segment List].

Using a Strava Live Segment While Riding

When the Strava live segments have been transferred to the device, configure a setting on the device and then ride to the start point of a segment.

- 1 Press the [Menu] button.
- 2 Use the [←]/[→] buttons to select [Settings] and then press the [Confirm] button.

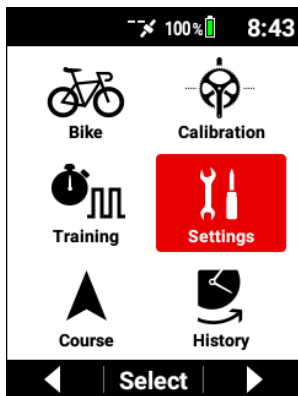

- 3** Use the [←]/[→] buttons to select [Strava Live Segment] and then press the [Confirm] button.

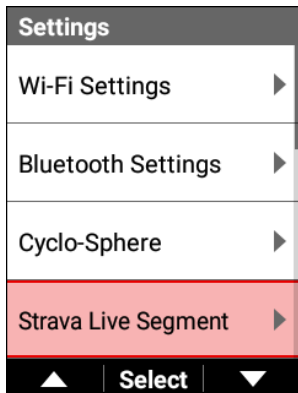

- 4** Use the [←]/[→] buttons to select [Enable] and then press the [Confirm] button to select the check box.

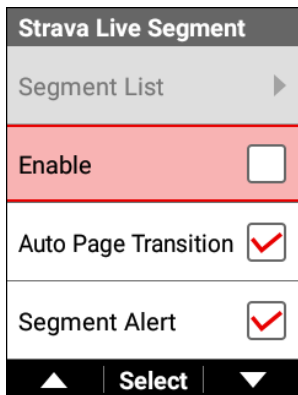

5 Press the [Menu] button to return to the meter screen page.

■ Riding to the Start Point of One of the Segments

The display changes in stages as you get nearer to the segment.

For example, the display becomes as follows when you are within 1 km of the segment and farther than 200 m.



When you reach the start point of the segment, the display becomes as follows and the live segment starts automatically.

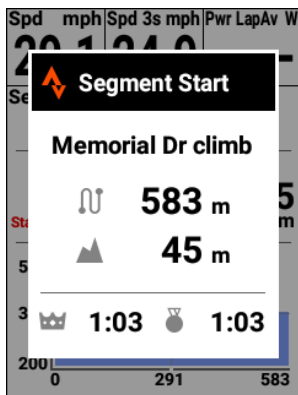

Note

- A time to indicate that you are ahead or behind in comparison to the King of the Mountains (KOM) or your personal record (PR) can also be displayed in real time while riding in a segment.

■ *Changing the Display Type of a Data Field*

You can ride while using this as a target for pacing yourself.

- Even if you pass the start point of another segment while riding in a segment, the current segment will not end.

■ Riding to the End Point of the Segment

When you arrive at the end point, the time difference from the KOM or PR and the elapsed time when you reached the goal are displayed.

When you ride more than 200 m away from the course of the segment, you are notified that you have left the segment and the live segment stops.

Disabling the Live Segment Function

You can disable the Live Segment function if you do not wish to use it.

- 1** Press the [Menu] button.
- 2** Use the [←]/[→] buttons to select [Settings] and then press the [Confirm] button.

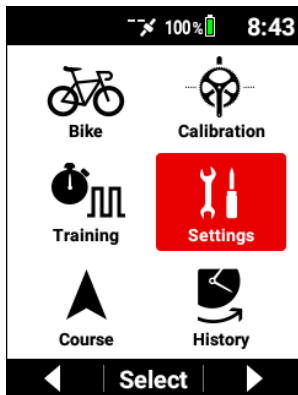

- 3** Use the [←]/[→] buttons to select [Strava Live Segment] and then press the [Confirm] button.

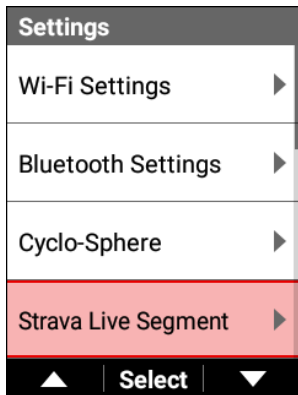

- 4** Use the [←]/[→] buttons to select [Enable] and then press the [Confirm] button to clear the check box.

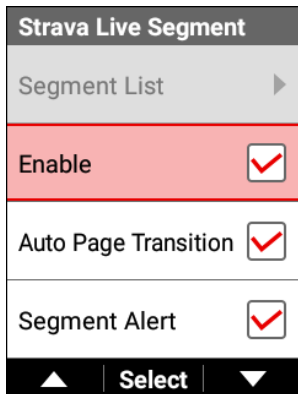

When the check box is cleared, the Live Segment function is disabled.

Automatically Switching to the Screen That Matches the Segment

If the [Auto Page Transition] check box is selected, the page will switch automatically to a page with data fields including the segment when you approach within 200 m of the segment.

- 1 Press the [Menu] button.**
- 2 Use the [←]/[→] buttons to select [Settings] and then press the [Confirm] button.**

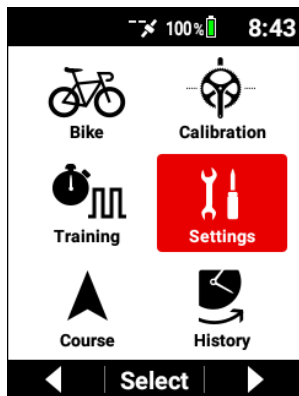

- 3** Use the [←]/[→] buttons to select [Strava Live Segment] and then press the [Confirm] button.

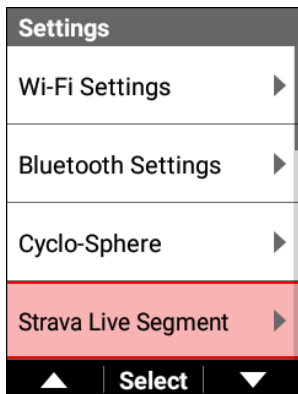

- 4** Use the [←]/[→] buttons to select [Auto Page Transition] and then press the [Confirm] button to select the check box.

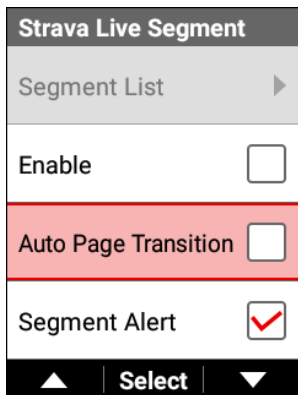

When the check box is selected, the Auto Page Transition function is enabled.

Using the Segment Alert Function

If the [Segment Alert] check box is selected, you will be notified of the distance until a segment or of the start and end of a segment at the following timing.

- When a segment within 1 km is found
- 200m, 656mile or less number distance will show.
- When you have reached a segment start point ("Segment Start" is displayed.)
- When you have reached a segment end point ("Segment Complete" is displayed.)

1 Press the [Menu] button.

2 Use the [←]/[→] buttons to select [Settings] and then press the [Confirm] button.

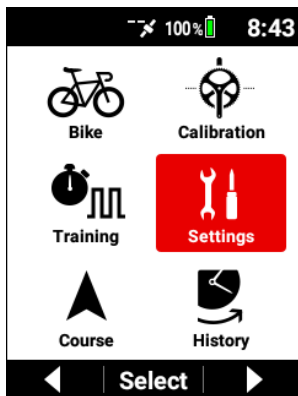

- 3** Use the [←]/[→] buttons to select [Strava Live Segment] and then press the [Confirm] button.

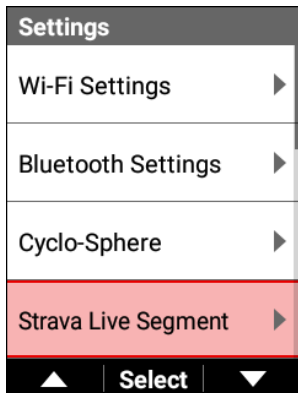

- 4** Use the [←]/[→] buttons to select [Segment Alert] and then press the [Confirm] button to select the check box.

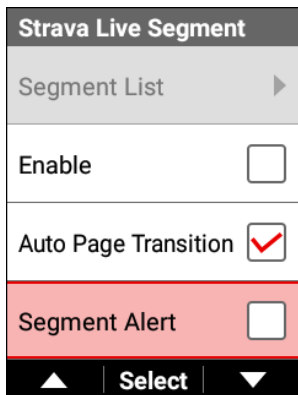

When the check box is selected, the Segment Alert function is enabled.

Using the Live Partner Function

This function allows you to wirelessly connect two cyclocomputers that support the Live Partner function and then set one as the coach (receives measurement values from the other party) and the other as the partner (sends measurement values to the other party) to receive and send measurement data in real time.

This allows the coach to set a pace suitable for the conditions because the coach can ride while viewing the partner's power, cadence, and other measurement values.

To use the Live Partner function, configuration of the Bluetooth setting on the device is required.

Coach and Partner Configuration Patterns

A maximum of three devices (CH1 to CH3) can be connected both on the receiving side and on the sending side.

When you will be the coach and you wish to select three partners, set [CH1] to partner 1, [CH2] to partner 2, and [CH3] to partner 3.

Then, get the partners to set you as the coach for one of [CH1] to [CH3].

Example: One coach and multiple partners

The coach can ride while viewing the riding state of partners 1, 2, and 3.



Example: Multiple coaches and one partner

Coaches 1, 2, and 3 can ride while viewing the riding state of partner 1.



Example: Two riders who are both a coach and partner

The riders can ride while viewing each other's riding state.



Coach and Partner Communication Distance

The maximum communication distance is approximately 30 m.

If a party goes out of the communication range, a message appears to notify that the rider has gone out of range.

If the rider comes closer after that, a message appears to notify that the rider has come in range.

Option Settings of the Live Partner Function

■ Adding a Partner

A partner can be added by a coach.

Registering a partner requires the setting to add a coach to be set on the partner's cyclocomputer at the same time.

For details, refer to the following.

Adding a Coach

- 1 Press the [Menu] button.**
- 2 Use the [←]/[→] buttons to select [Settings] and then press the [Confirm] button.**

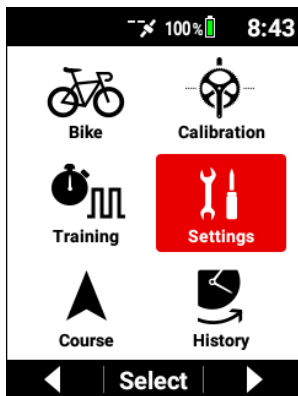

- 3 Use the [←]/[→] buttons to select [Live Partner] and then press the [Confirm] button.

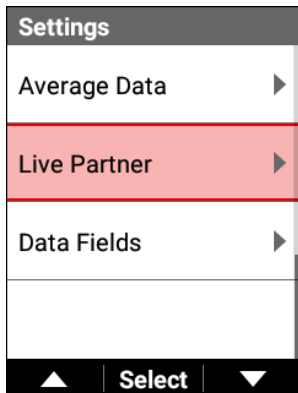

- 4 Use the [←]/[→] buttons to select one of [CH1]/[CH2]/[CH3] and then press the [Confirm] button.

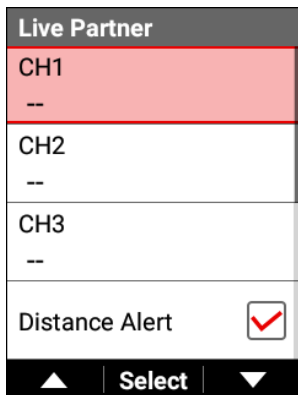

Note

- In [Bluetooth Setting], enable the channel to be used.
[Bluetooth Setting](#)
- If there is no available channel, refer to the following and then delete a registered partner or coach.
[Deleting a Partner or Coach](#)

- 5 Use the [←]/[→] buttons to select [Add Partner] and then press the [Confirm] button.**



The "Add Partner, Searching" message appears and a search for partners that can be connected in the surrounding area starts. A list of device numbers are displayed as connection candidates for the found partners. Search may take more than 1 minute.

Note

- The procedure of "Add Coach" needs to be performed on the partner's cyclocomputer.
For details, refer to the following.
[Adding a Coach](#)

- 6** Use the [←]/[→] buttons to select the partner you wish to register and then press the [Confirm] button.

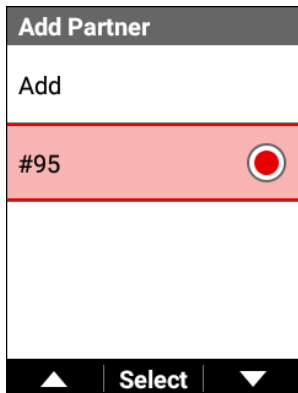

Note

- If the partner you wish to add is not displayed in the list, return to the previous screen and select [Add Partner] again.

- 7** Use the [←]/[→] buttons to select [Add] and then press the [Confirm] button.

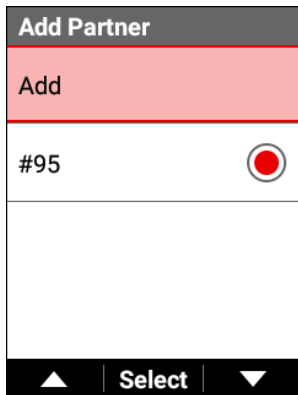

A connection approval request is sent to the partner and the "Add Partner Confirming permission to add Partner." message appears. If addition approval is given by the partner, the "Device Number:User Name Added to Partner" message appears.

Note

- When a coach is added by a partner, the "Add Coach Your device number is ***." message appears.
- When an addition approval request is sent from a coach, the "Add Coach Device Number:User Name Add to coach?" message appears on the partner side.
If you press the [Confirm] button, addition approval is sent.
- The coach side will be in the wait state until a response to the connection approval request is received.
If you press the [Menu] button or [Confirm] button on the device, the wait state is canceled.
- If connection approval is canceled by the partner, the connection is not permitted.

- 8 Press the [Confirm] button and then check the status displayed for the partner added to the specified channel number.

■ Adding a Coach

A coach can be added by a partner.

Registering a coach requires the setting to add a partner to be set on the coach's cyclocomputer at the same time.

For details, refer to the following.

[Adding a Partner](#)

- 1 Press the [Menu] button.
- 2 Use the [←]/[→] buttons to select [Settings] and then press the [Confirm] button.

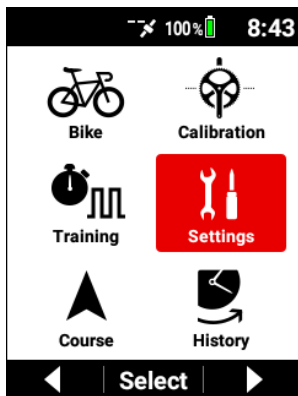

- 3 Use the [←]/[→] buttons to select [Live Partner] and then press the [Confirm] button.

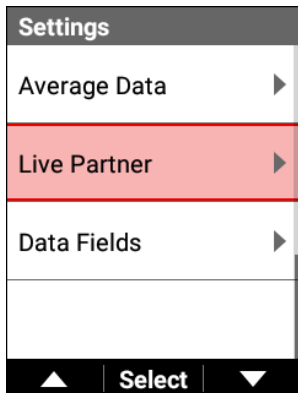

- 4 Use the [←]/[→] buttons to select one of [CH1]/[CH2]/[CH3] and then press the [Confirm] button.

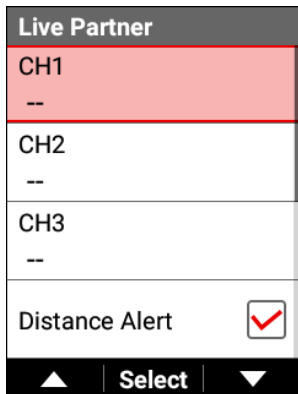

Note

- In [Bluetooth Setting], enable the channel to be used.
[Bluetooth Setting](#)
- If there is no available channel, refer to the following and then delete a registered partner or coach.

- 5 Use the [←]/[→] buttons to select [Add Coach] and then press the [Confirm] button.



A search for cyclocomputers that can be connected in the surrounding area starts.

Search may take more than 1 minute.

When the partner addition approval request is sent by a coach, one candidate is displayed automatically and the "Add to coach?" message appears.

6 Press the [Confirm] button.

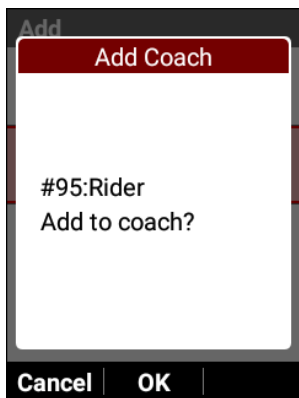

If permission is given for the addition approval request by the partner, the "Added to Partner" message appears together with the partner's device information on the cyclocomputer of the coach and the connection is permitted.

Also, the "Added to coach." message appears together with the coach's device information on partner side to notify that a connection has been established.

Note

- To not add the coach, press the [←] button.
- If the cyclocomputer you wish to add is not displayed in the list, return to the previous screen and select [Add Coach] again.

7 Check the status displayed for the coach added to the specified channel number.

Note

- The partner side will be in the wait state until a response to the sent connection permission is received. If one minute elapses or the [Menu] button is pressed in the wait state, the connection process is canceled.

- If the connection process is canceled by the coach, the connection is not permitted.

Viewing the partner information screen

This section describes how to view the information screen of a party registered as a partner.

- 1 Press the [Menu] button.**
- 2 Use the [←]/[→] buttons to select [Settings] and then press the [Confirm] button.**

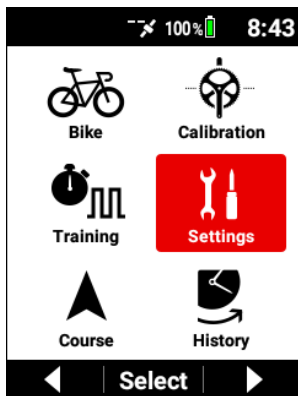

- 3** Use the [←]/[→] buttons to select [Live Partner] and then press the [Confirm] button.

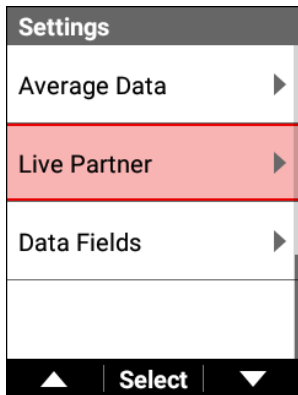

- 4** Use the [←]/[→] buttons to select the channel number of the registered partner for which you wish to view the information screen and then press the [Confirm] button.

The partner number, connection status, device number, and user name are displayed for the corresponding channel.

If a coach is connected, the coach number is not displayed.

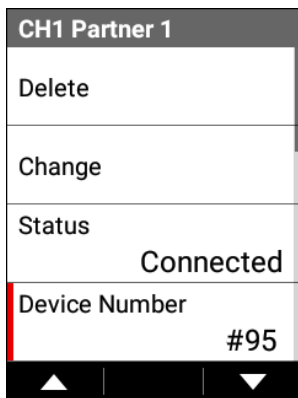
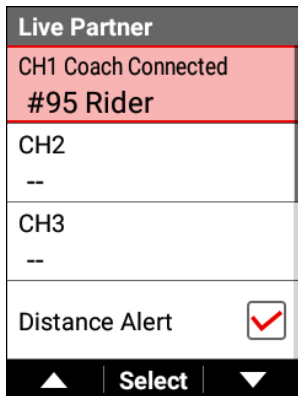

You can check the following items by using the [←]/[→] buttons to switch the item.

- Status
- Device number
- User name
- 3-second average power
- Lap average power

- TSS
- Intensity
- Heart rate
- Consumed calories

If the numerical values cannot be displayed for reasons such as the power meter and pedaling monitor connections on the partner side not being enabled or the device searching for the partner because, for example, you have moved out of range, "- -" is displayed.

■ Deleting a Partner or Coach

Delete a registered partner or coach.

- 1 Press the [Menu] button.**
- 2 Use the [←]/[→] buttons to select [Settings] and then press the [Confirm] button.**

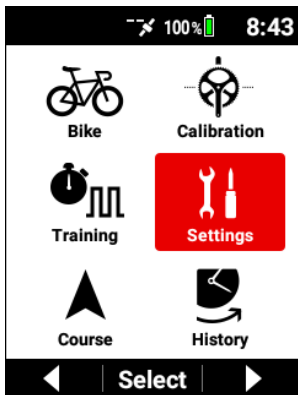

- 3 Use the [←]/[→] buttons to select [Live Partner] and then press the [Confirm] button.

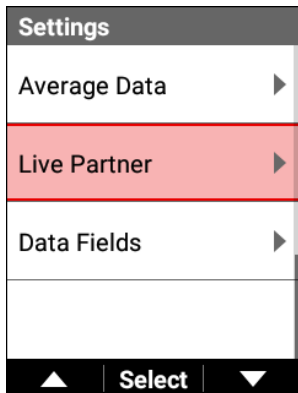

- 4 Use the [←]/[→] buttons to select the channel number to which the partner or coach is registered and then press the [Confirm] button.

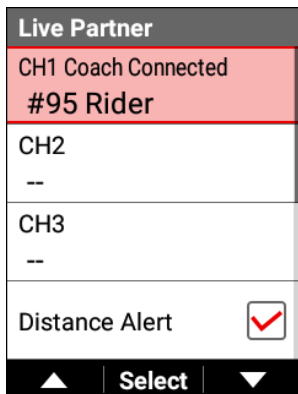

- 5 Use the [←]/[→] buttons to select [Delete] and then press the [Confirm] button.

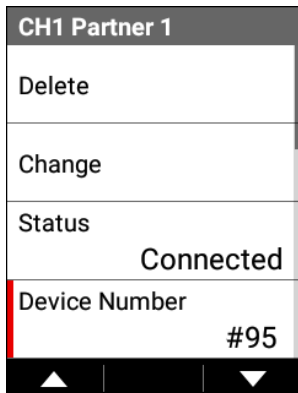

- 6 Press the [Confirm] button.

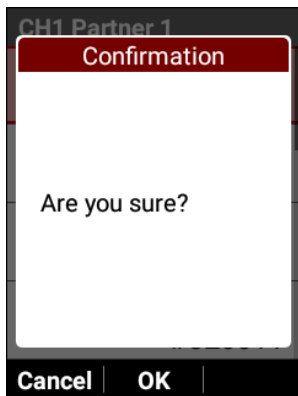

The coach or partner is deleted. If you delete a coach or partner that was connected, a message notifying of the deletion appears on the other party side.

If you delete a coach or partner that was not connected, a deletion message is displayed on this device but not on the other party side so be careful because the other party side will continue to search for this device.

■ Viewing the Partner Screen

This section describes how to view the partner screen that is displayed on the coach side.

Switch to the page containing the partner information you wish to display.

There are two kinds of partner information: a graph type and numerical value type.

The graph type displays multiple information, such as the user name of the partner and intensity graph, all together.

The displayed information differs depending on the size of the data field.

The numerical value type for a partner can display information, such as the average power, intensity, or heart rate, individually.

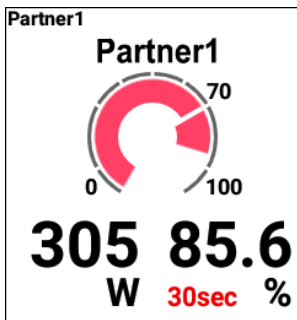

Graph parts for partners display the following information.

- Partner number
- User name of partner
- Intensity graph
- 3-second average power
- Intensity

Note

- Press the [Confirm] button to display the data field you wish to display for the partner enlarged and then press and hold the [Confirm] button. Select the graph for the data field type and select the partner for the data category. Select the partner number for the partner.
- If you use the [←]/[→] buttons to select [Change] and then press the [Confirm] button, you can change the partner number.
- If the power meter and pedaling monitor connections on the partner side have not been enabled or the device is searching for the partner because, for example, you have moved out of range, "- -" is displayed for the 3-second average power and intensity.
- If the partner has a heart rate sensor connected when a power meter and pedaling monitor are not connected, the heart rate is displayed in the place of the 3-second average power and the maximum percentage heart rate is displayed in the place of the intensity graph.

Changing a partner number

You can change the partner number displayed in the partner screen. For example, when partner 1 is registered to [CH1] and partner 2 is registered to [CH2], partner 3 who is added to [CH3] can be displayed as partner 1. In this case, the partner who was initially partner 1 is changed automatically to partner 3.

- 1** Press the [Menu] button.

- 2 Use the [←]/[→] buttons to select [Settings] and then press the [Confirm] button.

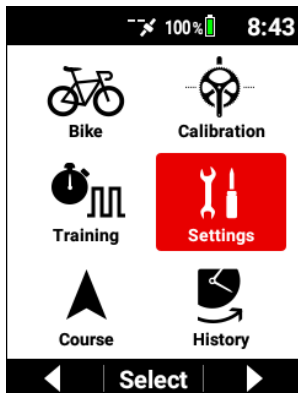

- 3 Use the [←]/[→] buttons to select [Live Partner] and then press the [Confirm] button.

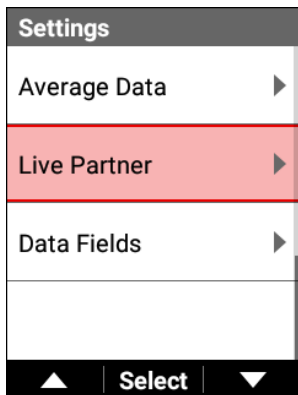

- 4 Use the [←]/[→] buttons to select the channel number to which the partner or coach is registered and then press the [Confirm] button.

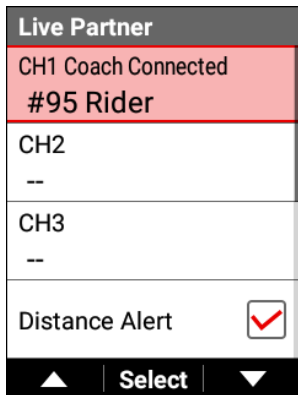

- 5 Use the [←]/[→] buttons to select [Change] and then press the [Confirm] button.

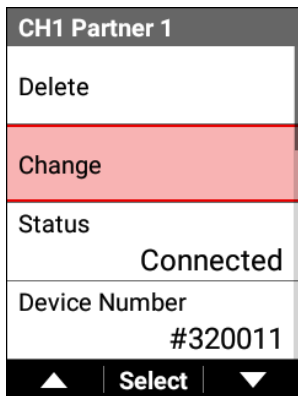

- 6 Use the [←]/[→] buttons to select a partner number and then press the [Confirm] button.

Change	
Partner 1	<input checked="" type="radio"/>
Partner 2	<input type="radio"/>
Partner 3	<input type="radio"/>
▲ Select ▼	

The partner number is changed.

■ Option Settings of the Live Partner Function

- 1 Press the [Menu] button.

- 2 Use the [←]/[→] buttons to select [Settings] and then press the [Confirm] button.

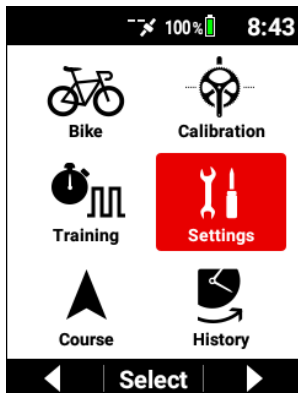

- 3 Use the [←]/[→] buttons to select [Live Partner] and then press the [Confirm] button.

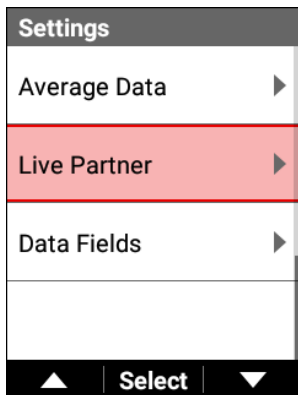

Setting item	Description
Distance Alert	Select this check box to be notified when the distance between the other party and your bike opens up and the other party goes out of the communication range. Clear this check box to not be notified. You are also notified when your bike comes near the other party and the connection is reestablished.
Intensity Alert 90% , Intensity Alert 80% , Intensity Alert 70%	Select this check box to be notified when the partner's intensity during riding exceeds the set percentage. Clear this check box to not be notified.

The function operates only in the following cases.

- When the connected partner has a power meter, pedaling monitor, or smart trainer connected
- When the MMP setting is enabled on the partner side
- When the intensity values of the partner side are received normally

Analyzing Log Data

Displaying Log Data

The past log data or past lap log data can be analyzed on the device.

Note

- Saved log data is displayed automatically after it is saved.

- 1** Press the [Menu] button.
- 2** Use the [←]/[→] buttons to select [History] and then press the [Confirm] button.



- 3** Use the [←]/[→] buttons to select [Log Data] and then press the [Confirm] button.

When the data is separated by one or more laps during logging, the current log data is selected.

The most recent log data is selected before logging starts or after logging is saved.

History	
Log Data	LOG_2018_11_11_20_49_32
Lap	All
Riding Time	21 min 27 sec
Distance	1000 ft
▲ Select ▼	

- 4** Use the [←]/[→] buttons to select the log data you wish to display and then press the [Confirm] button.

Log Data	
Current	<input type="radio"/>
LOG_2018_11_12_14_55_19	<input checked="" type="radio"/>
LOG_2018_11_11_20_49_32	<input type="radio"/>
LOG_2018_11_11_20_47_32	<input type="radio"/>
▲ Select ▼	

- 5 Use the [←]/[→] buttons to select [Lap] and then press the [Confirm] button.

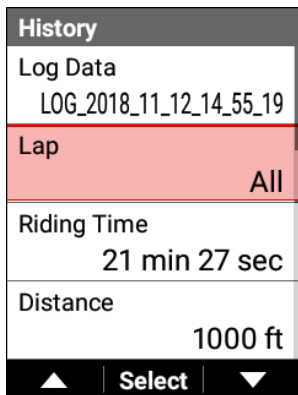

- 6 Use the [←]/[→] buttons to select the interval between laps you wish to display and then press the [Confirm] button.



The log data for the selected interval between laps is selected.

When [All] is selected, the log data of all intervals is displayed.

- 7 Use the [←]/[→] buttons to select the item you wish to view.

Editing Log Data

You can edit some log data on the device.

■ Editing the Date and Time of Log Data

- 1 Display the log data you wish to edit.

Displaying Log Data

- 2 Use the [←]/[→] buttons to select [Edit Date & Time] and then press the [Confirm] button.

History	
Speed Avg	2.4 mph
Speed Max	4.8 mph
Elevation Gain	25.5 ft
Edit Date & Time	▶

▲ | Select | ▼

- 3** Use the [←]/[→] buttons to select [Date] and then press the [Confirm] button.

Edit Date & Time	
Date	11/12/2018
Time	2:55:19 PM
Save	
▲	Select ▼

- 4** Use the [←]/[→] buttons to enter the date you wish to set and then press the [Confirm] button.

Date		
11	/	12 / 2018
–	Next	+

Each press of the [Confirm] button moves the cursor in the order of year, month, and day.

If you press the [Confirm] button after the cursor has been moved to day, the date is confirmed and the previous screen reappears.

- 5 Use the [←]/[→] buttons to select [Time] and then press the [Confirm] button.**

Edit Date & Time	
Date	11/12/2018
Time	2:55:19 PM
Save	
▲ Select ▼	

- 6 Use the [←]/[→] buttons to enter the time you wish to set and then press the [Confirm] button.**

Each press of the [Confirm] button moves the cursor in the order of hour, minute, and second.

If you press the [Confirm] button after the cursor has been moved to second, the time is confirmed and the previous screen reappears.

- 7 Use the [←]/[→] buttons to select [Save] and then press the [Confirm] button.

Edit Date & Time	
Date	11/12/2018
Time	2:55:19 PM
Save	
▲	Select ▼

The changes to the date and time are confirmed and the previous screen reappears.

■ Deleting Log Data

- 1 Display the log data you wish to edit.

Displaying Log Data

- 2 Use the [←]/[→] buttons to select [Delete] and then press the [Confirm] button.

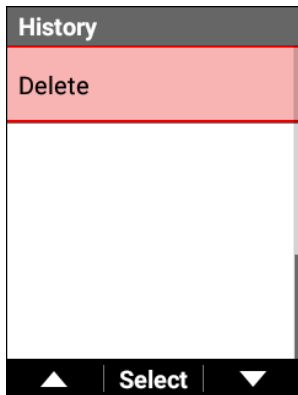

- 3 Press the [Confirm] button.

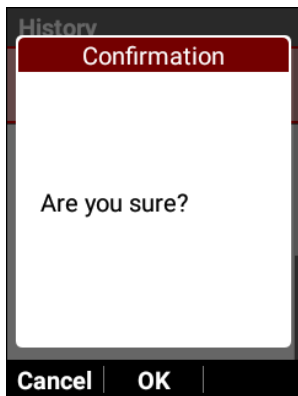

The selected log data is deleted.
If you press the [←] button, deletion is canceled.

Generating FIT Files

FIT files can be generated on the device and then imported into a PC analysis tool or other software.

Generated FIT files are stored in the “Computer/ CA600/ Internal storage/ Pioneer/ LogFit” folder.

The file name of a FIT file is the date and time that logging started.

Example: LOG_2019_01_01_08_20.fit

1 Display the log data you wish to edit.

Displaying Log Data

2 Use the [←]/[→] buttons to select [Create FIT File] and then press the [Confirm] button.

History	
Speed Avg	20.1 km/h
Speed Max	39.2 km/h
Elevation Gain	310.4 m
Create FIT File	
▲	Select ▼

Generating a FIT file may take several minutes.

Generation will be canceled if you perform operations such as starting logging during generation.

Performing Analysis Using Cyclo-Sphere

The content that can be analyzed, data that can be set, etc. using Cyclo-Sphere differs depending on the access method.

■ Cyclo-Sphere Analysis App (for iPhone)

The Cyclo-Sphere Analysis App can be downloaded from the following URL.

<https://cyclo-sphere.com/app/>

After training, you can view the analyzed riding results using your iPhone even when you are out.

The training assistance function is also supported and rankings can also be displayed.

The segment function is also supported and you can use both a section segment and a smart segment.

■ Smartphone Version of the Cyclo-Sphere Website

<https://cyclo-sphere.com/>

(The smartphone version can be opened from your iPhone or Android device.)

This website allows you to use everything except the segment function of the Cyclo-Sphere Analysis App.

■ PC Version of the Cyclo-Sphere Website

<https://cyclo-sphere.com/>

This website allows you to view detailed analysis results in a large window.

The window can also be customized so you can arrange the items you wish to analyze into an easy-to-view layout.

Access the Cyclo-Sphere website from the following URL.

For how to view and how to use the screen, refer to the help page of Cyclo-Sphere.

<https://cyclo-sphere.com/help>

In addition to the above, the Pioneer cyclesports website provides various content to offer hints on usage and skill improvement including videos that analyze and examine top athletes.

<http://pioneer-cyclesports.com/jp/>

Performing Analysis Using Strava

Strava is a web service/app to record running, riding, and other activities.

For details on Strava, refer to the following URL.

<https://www.strava.com/features>

Note

- You need to register for a Strava account.

1 Select the following in order in the Cyclo-Sphere Analysis App.

[More] > [Account Management] > [Web Link]

When configuring the settings on the PC version of the Cyclo-Sphere website, refer to the help page of Cyclo-Sphere.

<https://cyclo-sphere.com/help>

2 Tap [Strava].

3 Tap [Link].

The login screen of Strava appears. Log in.

4 When the screen for approving Cyclo-Sphere appears, give approval.

Approval for Cyclo-Sphere to access Strava is given and the previous screen reappears.

If [Link] is not active, Cyclo-Sphere and Strava are being linked.

Note

- If you select the [Automatically transfer ride log data to STRAVA™ after uploading] check box, the log data uploaded from the device will also be transferred automatically to Strava.
- If you wish to make the log data of Cyclo-Sphere public in Strava, select the "Log files transferred to STRAVA™ will be made public on STRAVA™" check box.
- Since analysis is performed in Cyclo-Sphere, it may take a while for the data to be displayed in Strava.

Performing Analysis Using TrainingPeaks

You can analyze your activities using TrainingPeaks.

Preparation such as creating an account on the TrainingPeaks website or in the TrainingPeaks App is required.

For details, refer to the TrainingPeaks website.

<https://www.trainingpeaks.com/>

1 Select the following in order in the Cyclo-Sphere Analysis App.

[More] > [Account Management] > [Web Link]

When configuring the settings on the PC version of the Cyclo-Sphere website, refer to the help page of Cyclo-Sphere.

<https://cyclo-sphere.com/help>

2 Tap [TrainingPeaks].

3 Tap [Link].

The login screen of TrainingPeaks appears. Log in.

4 When the approval screen appears, confirm approval.

Approval for Cyclo-Sphere to access TrainingPeaks is given and the previous screen reappears.

If [Link] is not active, Cyclo-Sphere and TrainingPeaks are being linked.

Note

- If you select the [Automatically transfer ride log data to TrainingPeaks™ after uploading] check box, the log data uploaded from the device will also be transferred automatically to Strava.
- If you wish to make log data in Cyclo-Sphere public, select the "Log files transferred to TrainingPeaks™ will be made public on TrainingPeaks™" check box.
- Since analysis is performed in Cyclo-Sphere, it may take a while for the data to be displayed in TrainingPeaks.

Navigation

Transferring Courses

You can transfer Courses you create in service like Ride with GPS and Strava to the device.

For details on how to create courses, check the help and other information of the corresponding service.

■ Ride with GPS Setup

Access the "<https://ridewithgps.com/>" dedicated site and register an account.

■ Strava Setup

Access the "<https://www.strava.com/>" dedicated site and register an account.

■ Transferring from a Smartphone App

Transfer routes of the Ride with GPS or Strava service from your iPhone or Android device to this device.

1 Save your routes in Ride with GPS or Strava.

Transfer your routes to the device (synchronize).

Perform synchronization of Ride with GPS or Strava in the Cyclo-Sphere Control App in the same way as the training menu synchronization of TrainingPeaks.

Create routes in Ride with GPS and then save them to MyRoutes.

Save routes to MyRoutes in Strava and then add stars to the routes you wish to transfer.

When the device and Cyclo-Sphere Control App are connected, the course files are automatically synchronized from each of the web services and then transferred to the course folder of the device.

Note

- The files can also be transferred to the course folder of the device by pressing the button to share TCX or FIT files from other course creation and mail applications, and selecting the Cyclo-Sphere Control App.
- If the [Limit data communication such as file transmission via only Wi-Fi.] check box in [Others] - [Cyclo-Sphere Control設定] of the Cyclo-Sphere Control App is selected, the course files are not downloaded to the Cyclo-Sphere Control App when there is no Wi-Fi connection.

- The [Get a course from Ride with GPS] check box in the [Others] - [Cooperation with other services] screen needs to be selected.
- The routes of the Strava service with star marks added are targets for transfer to the device as course files.
- The downloading of course files to the Cyclo-Sphere Control App may take a while depending on the lengths and number of courses and the communication state of the smartphone.
- The transferring of course files to the device may take a while depending on the lengths and number of courses.
- The FIT files that can be imported as course files are FIT files (course type) created with a service such as a course creation service. Log data in the FIT file format of another company's cyclocomputer and FIT files downloaded from Cyclo-Sphere, etc. (activity type) are not supported. FIT files generated on the device are also not supported.

■ Transferring Course Files Using a PC

You can transfer the course files you created in services such as Ride with GPS and Strava from a PC to the device.

- 1 Turn on the power of the device.**
- 2 When start up completes, use the provided USB cable to connect the device to your PC.**

The device is recognized as an MTP device on the PC.
- 3 Download the course files you created in services such as Ride with GPS and Strava to the PC.**

When you export your activities from each of the sites, save them in the TCX or FIT format.
- 4 Save the course files you downloaded to the PC to the device.**

Save the course files directly under "/CA600/Internal storage/Pioneer/ Course".

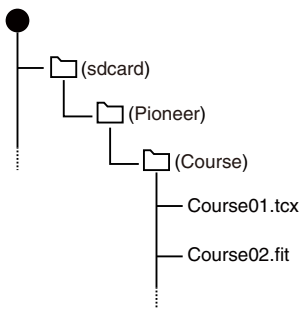

Note

- For MTP connection with Macintosh, please refer to the following URL for example.
<https://www.android.com/filetransfer/>

Selecting a Course

Select a course file that you transferred from your PC, iPhone, or Android device to this device as a course.

■ Selecting from the Transfer Folder

Select a course file that was transferred to the device via your PC or the Cyclo-Sphere Control App as a course.

- 1** Press the [Menu] button.

- 2 Use the [←]/[→] buttons to select [Course] and then press the [Confirm] button.



- 3 Use the [←]/[→] buttons to select [Course Select] and then press the [Confirm] button.

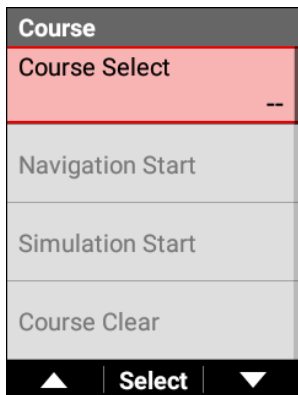

- 4** Use the [←]/[→] buttons to select [Course Folder] and then press the [Confirm] button.

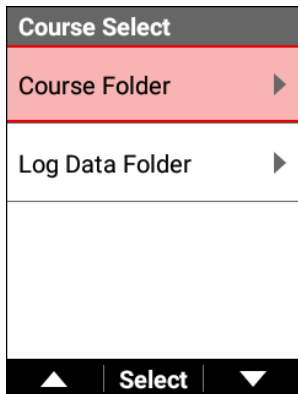

A list of the courses that were transferred to the device appears.

- 5** Use the [←]/[→] buttons to select the name of the course you wish to set and then press the [Confirm] button.

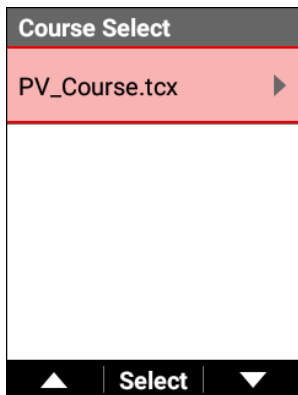

6 Check the course details.

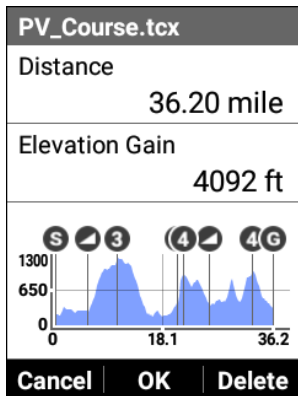

[Distance]: The mileage of the course is displayed.

[Elevation Gain]: Displays the total elevation gain of the course.

[Course Profile]: Displays the elevation information for the course.

7 Press the [Confirm] button.

The course is set.

If you press the [←] button, setting is canceled and the course list screen reappears.

Selecting from past Log Data

Select log data that was saved in the past to the device as a course.

1 Press the [Menu] button.

- 2 Use the [←]/[→] buttons to select [Course] and then press the [Confirm] button.



- 3 Use the [←]/[→] buttons to select [Course Select] and then press the [Confirm] button.

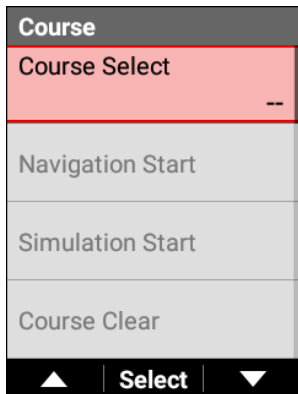

- 4** Use the [←]/[→] buttons to select [Log Data Folder] and then press the [Confirm] button.

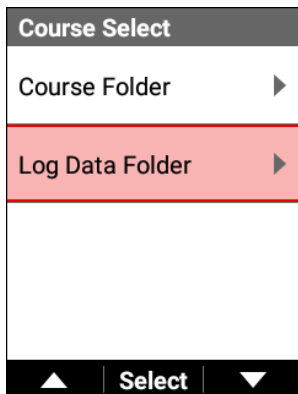

A list of the courses of the log data that was saved to the device appears.

- 5** Use the [←]/[→] buttons to select the log data you wish to set and then press the [Confirm] button.

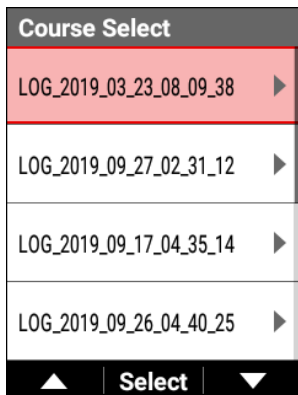

6 Check the course details.

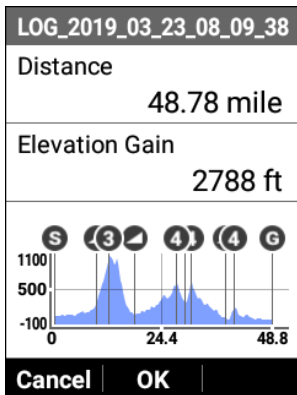

[Distance]: The mileage of the course is displayed.

[Elevation Gain]: Displays the total elevation gain of the course.

[Course Profile]: Displays the elevation information for the course.

7 Press the [Confirm] button.

The course is set.

If you press the [←] button, setting is canceled and the course list screen reappears.

Checking a Course

You can check the information of the selected course.

Cue sheet

Display the cue sheet for the selected course.

1 Press the [Menu] button.

- 2 Use the [←]/[→] buttons to select [Course] and then press the [Confirm] button.



- 3 Use the [←]/[→] buttons to select [Cue Sheet] and then press the [Confirm] button.

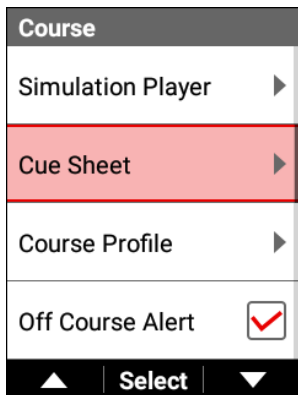

Course profile

Display the elevation graph for the selected course.

- 1 Press the [Menu] button.**
- 2 Use the [←]/[→] buttons to select [Course] and then press the [Confirm] button.**



- 3 Use the [←]/[→] buttons to select [Course Profile] and then press the [Confirm] button.

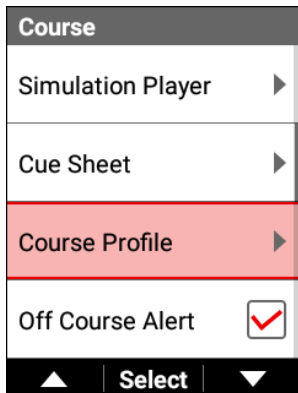

Cancel the course

Clear the set course.

- 1 Press the [Menu] button.

- 2** Use the [←]/[→] buttons to select [Course] and then press the [Confirm] button.



- 3 Use the [←]/[→] buttons to select [Course Clear] and then press the [Confirm] button.

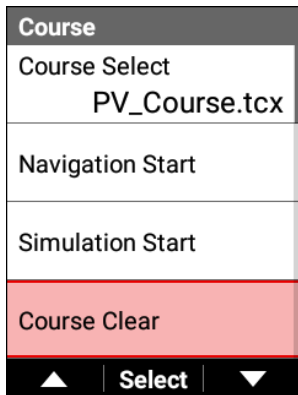

Navigation Settings

You can set the course navigation information.

- 1 Press the [Menu] button.

- 2 Use the [←]/[→] buttons to select [Course] and then press the [Confirm] button.

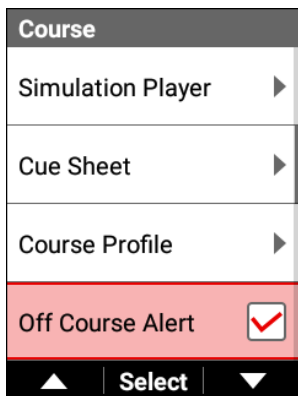

Setting item	Description
Off Course Alert	Select this check box to be alerted by a message and sound when you go off course. Clear this check box to not display a message.
Turn by Turn Guide	Select this check box to be alerted by a message and sound when you approach a left or right turn point. Clear this check box to not display a message.
Cue Point Guide	Select this check box to be alerted by a message and sound when you approach a cue point. Clear this check box to not display a message.
Auto Guide Zoom	Select this check box to enlarge the scale as you approach a left or right turn point or cue point from the scale set for the course of a graph part. Clear this check box to not enlarge the scale.
North Up	Select this check box to set the map orientation for the course to always orient the top of the map as North. With north-up display, place names and icons are displayed on the map and your bike position changes depending on the direction of travel. If you clear this check box to set heading up, place names are hidden on the map and your bike position is displayed fixed.
Auto Cue Point	Select this check box to generate "Mountain Cue Points" and "Left or Right Turn Points" automatically when a course is chosen. Cue points are not generated automatically if this check box is cleared. "Mountain Cue Points" are assessed as HC or 1st, 2nd, 3rd, or 4th mountains based on their height from base to peak. Individual cue points are generated for the base and peak, and course distance, average gradient, and elevation gain, from base to peak are added to messages. Cue points are not generated automatically when "Mountain Cue Points" or "Left or Right Turn Points" already exist in the course files.

Note

- You cannot switch to or from north-up display during logging.
- When you switch to or from north-up display (select or clear the check box), the device restarts the system.

Starting and Stopping Navigation

You can start and stop navigation for the set course.

- 1** Press the [Menu] button.
- 2** Use the [←]/[→] buttons to select [Course] and then press the [Confirm] button.

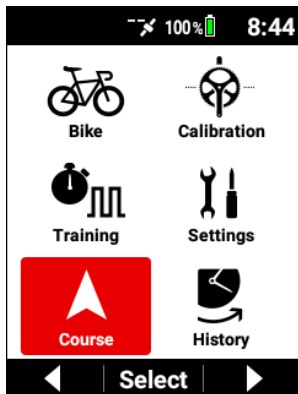

- 3 Use the [←]/[→] buttons to select [Navigation Start] and then press the [Confirm] button.

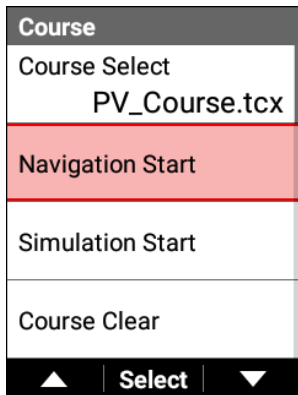

The meter screen reappears and navigation starts.

Note

- [Navigation Stop] is displayed during navigation. Use the [←]/[→] buttons to select it and then press the [Confirm] button to stop navigation.
- Navigation cannot be used during simulation.

Simulation

Simulate a course using an **ANT+** smart trainer (**ANT+FE-C**).

A course can be simulated by using a course file or past log data.

When you are using a smart trainer, simulation where the load automatically changes to match the gradient of the course is possible.

■ Smart Trainer Setting

Enable the smart trainer setting on the device.

- 1 Press the [Menu] button.

- 2** Use the [←]/[→] buttons to select [Bike] and then press the [Confirm] button.

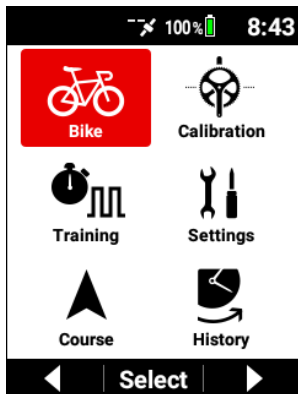

- 3** Use the [←]/[→] buttons to select [Sensor] and then press the [Confirm] button.

Enable [Course Link] in the sensor information of the smart trainer.

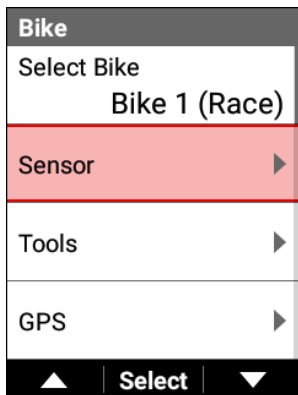

■ Starting and Stopping

You can start and stop simulation for the set course.

- 1 Press the [Menu] button.**
- 2 Use the [←]/[→] buttons to select [Course] and then press the [Confirm] button.**

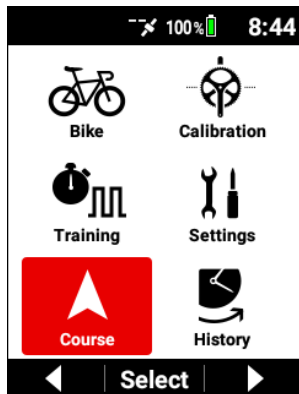

- Use the [←]/[→] buttons to select [Simulation Start] and then press the [Confirm] button.

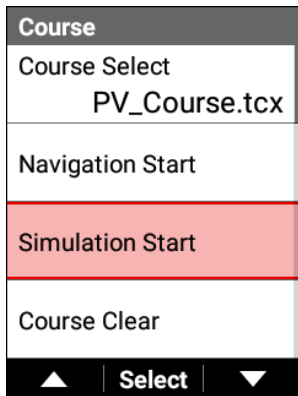

The meter screen reappears and simulation starts.

Note

- [Simulation Stop] is displayed during simulation. Use the [←]/[→] buttons to select it and then press the [Confirm] button to stop simulation.
- Simulation cannot be used during navigation.

■ Simulation Player

Check the current position information and change the position during simulation.

- Press the [Menu] button.

- 2 Use the [←]/[→] buttons to select [Course] and then press the [Confirm] button.

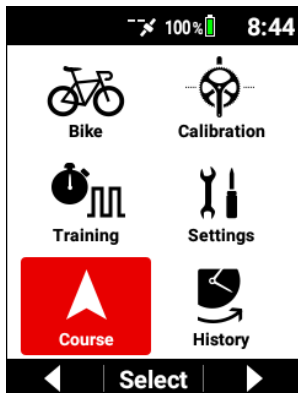

- 3 Use the [←]/[→] buttons to select [Simulation Player] and then press the [Confirm] button.

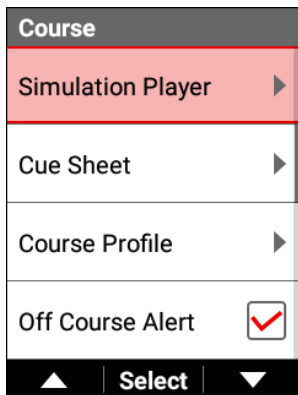

4 Check the simulation conditions.

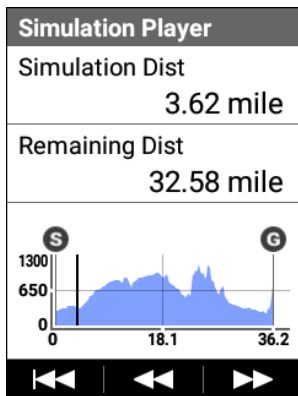

Each press of the [→] button moves forward by a distance of 10%, and each press of the [Confirm] button moves back by a distance of 5%. To return to the starting point press the [←] button.

Map Download

Download map data from a map data server via Wi-Fi.

Note

- The device has a map of some areas stored in it by default.
- When initializing this device, the default map will be deleted.

1 Enable Wi-Fi.

Wi-Fi Settings

2 Press the [Menu] button.

- 3 Use the [←]/[→] buttons to select [Course] and then press the [Confirm] button.



- 4 Use the [←]/[→] buttons to select [Map Download] and then press the [Confirm] button.

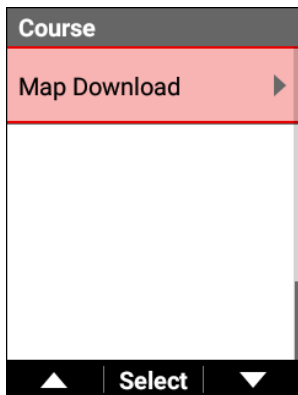

- 5** Use the [←]/[→] buttons to select [Add Map] and then press the [Confirm] button.

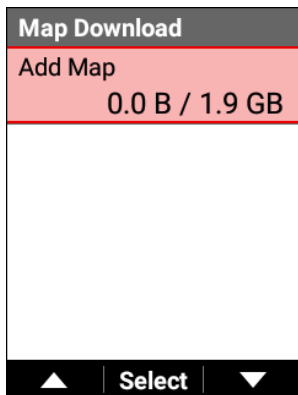

- 6** Use the [←]/[→] buttons to select the area of the map you wish to add and then press the [Confirm] button.

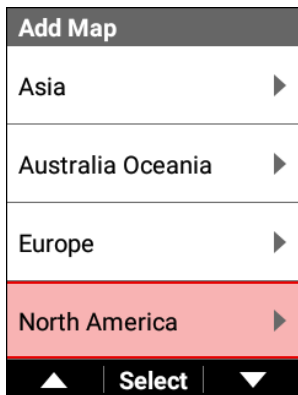

- 7** Use the [←]/[→] buttons to select the region of the map you wish to add and then press the [Confirm] button.

North America	
Alabama	1.00 / 46.9 MB
Alaska	1.00 / 403.7 MB
Alberta	1.00 / 131.4 MB
Arizona	1.00 / 88.0 MB

▲ | Select | ▼

When the size of the selected map exceeds the free space of the device, "Flash memory is full." is displayed.

- 8** Press the [Confirm] button.

Adding of the map starts. The device will restart the system automatically after adding of the map completes.

If you press the [←] button, adding of the map is canceled.

Note

- If logging is started during downloading of a map, adding of the map is canceled.

■ Checking Map Information

You can check the information of a map downloaded via Wi-Fi.

- 1** Press the [Menu] button.

- 2 Use the [←]/[→] buttons to select [Course] and then press the [Confirm] button.

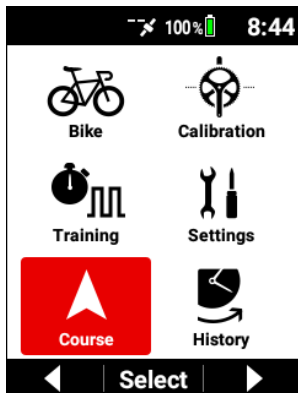

- 3 Use the [←]/[→] buttons to select [Map Download] and then press the [Confirm] button.

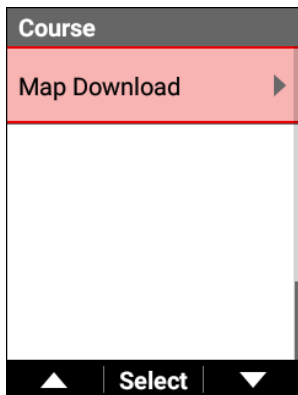

- 4 Use the [←]/[→] buttons to select the name of a saved map and then press the [Confirm] button.

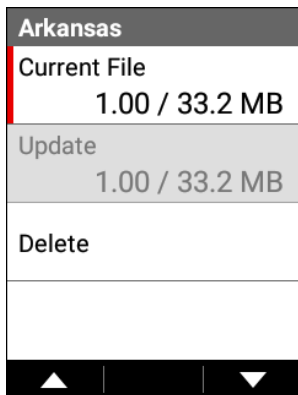
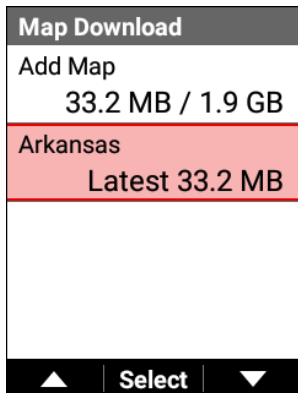

Displays the version and file size of the map.

[Update]: Starts updating the map file.

If there is no information to update, this cannot be selected.

[Delete]: Displays the deletion confirmation screen. If you press the [Confirm] button in the deletion confirmation screen, the selected map is deleted and the device restarts.

The device restarts the system after an update finishes.

When an update is started, the current map data is deleted.

If an update fails, the device restarts automatically so add the map data again.

To add a new map, select [Add Map], select an area, select a region, and download the map.

Pedaling Monitor

Initial Setup

This section describes how to connect a pedaling monitor, configure various settings, and perform zero point calibration.

■ Connecting

Connect the pedaling monitor sensors to the device.

- 1 Turn the crankset of the bike at least three times to start the left and right transmitters.**
Refer to the user's guide of your sensors for mounting instructions.
- 2 Press the [Menu] button.**
- 3 Use the [←]/[→] buttons to select [Bike] and then press the [Confirm] button.**



- 4 Use the [←]/[→] buttons to select [Sensor] and then press the [Confirm] button.

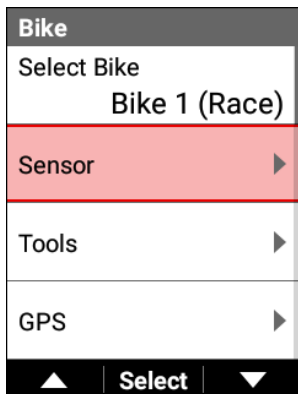

- 5 Use the [←]/[→] buttons to select [Add Sensor] and then press the [Confirm] button.

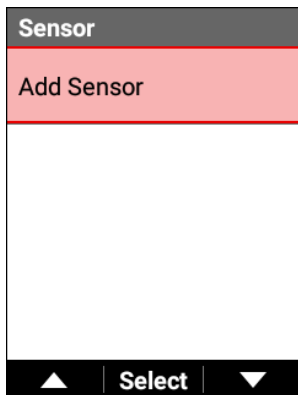

A search for nearby connectable sensors is performed and the found sensors are listed.

6 Use the [←]/[→] buttons to select the sensors to add and then press the [Confirm] button.

Select the check boxes for the left pedaling monitor and right pedaling monitor.

The screenshot shows a mobile application interface titled "Add Sensor". At the top, there is a grey header with the text "Add Sensor". Below the header is a white area with the word "Add". A red horizontal line separates this from a list of sensors. The first sensor is "Pedaling Monitor L #18" with a red checkmark in a box to its right. The second sensor is "Pedaling Monitor R #18" with a red checkmark in a box to its right. Below the list is a white area, and at the bottom is a black bar with a white triangle pointing up on the left, the word "Select" in the center, and a white triangle pointing down on the right.

- 7** Use the [←]/[→] buttons to select [Add] and then press the [Confirm] button.

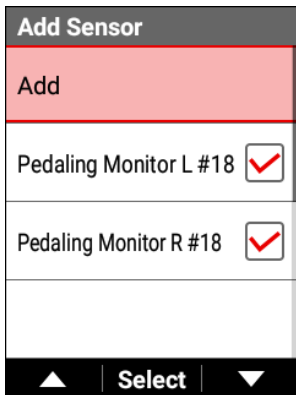

The left pedaling monitor and right pedaling monitor for which you selected the check boxes are added to the sensor list.

■ Configuring the Settings Using Cyclo-Sphere Control App

You can configure the settings of the pedaling monitor sensor using Cyclo-Sphere Control App.

All of the settings of the pedaling monitor sensors can be configured in Cyclo-Sphere Control App.

For details, refer to the following website.

<https://cyclo-sphere.com/app/>

■ Configuring the Settings on the Device

You can configure the settings of the pedaling monitor sensors on the device.

Changing the mode

Set the mode of pedaling monitor sensors to any of the following three modes.

① Pedaling monitor mode

This mode can measure, for example, pedaling efficiency and cadence, and allows you to get the most out of the functions of this product.

② Dual power meter mode

Use this mode when connecting as the dual model of the ANT+ power meter.

The total power value for the left and right sensors, left and right balance, torque effect, pedal smoothness, cadence value, and other values are transmitted.

③ Single power meter mode

Use this mode when connecting as the single model of the ANT+ power meter.

The power value of the left or right sensor is doubled and then transmitted.

The torque effect, pedal smoothness, cadence value, and other values are also transmitted.

1 Press the [Menu] button.

2 Use the [←]/[→] buttons to select [Bike] and then press the [Confirm] button.

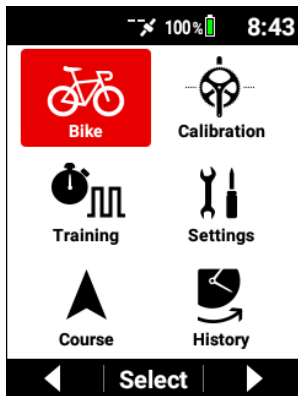

- 3** Use the [←]/[→] buttons to select [Tools] and then press the [Confirm] button.

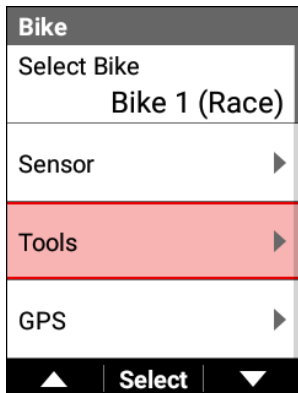

- 4** Use the [←]/[→] buttons to select [Pedaling Settings] and then press the [Confirm] button.

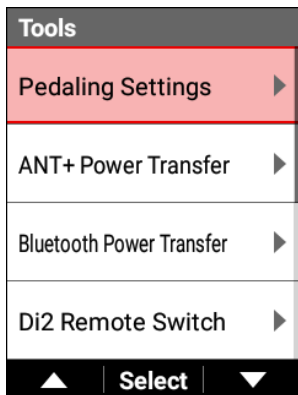

- 5** Use the [←]/[→] buttons to select [Mode Switch] and then press the [Confirm] button.

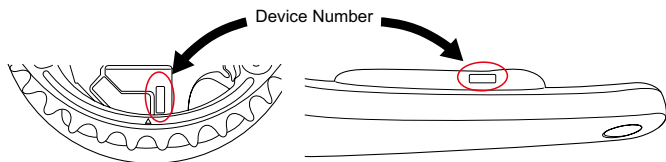
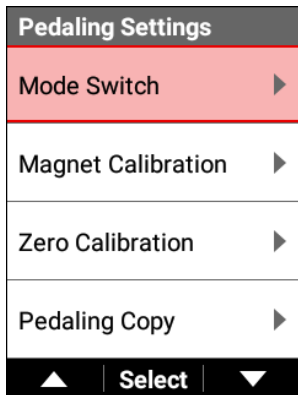

Check that the device numbers are those of the pedaling monitor sensors being used.

If they differ, newly enter them.

Clear any sensor for which to not change the mode.

When changing to dual power, select the check boxes for both the left and right sensors.

- 6 Use the [←]/[→] buttons to select [Device Number] and then press the [Confirm] button.

Mode Switch	
Left	<input checked="" type="checkbox"/>
Device Number	18
Right	<input checked="" type="checkbox"/>
Device Number	18

▲ | Select | ▼

- 7 Use the [←]/[→] buttons to enter the device numbers and then press the [Confirm] button.

Device Number				
0	0	0	1	8

— | Next | +

Each press of the [Confirm] button moves the cursor to the next digit place down.

If you press the [Confirm] button after the cursor has been moved to the ones place, the numerical value is confirmed and the previous screen reappears.

- 8 Turn the crankset of the bike at least three times to start the left and right transmitters.**

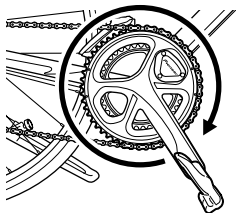

Once the transmitters are started, connect them with the device within 5 minutes.

- 9 Use the [←]/[→] buttons to select the mode to which to change and then press the [Confirm] button.**

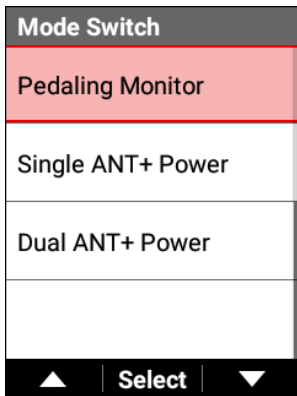

A sensor search starts. The search may take longer than one minute.

- 10** Check that "Success" is displayed on the screen of the device and then press the [Confirm] button.

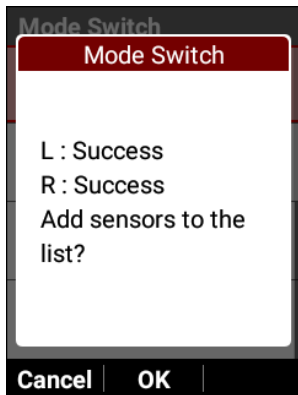

If you changed the mode to the pedaling monitor mode, the sensors are added to the sensor list and establishing a connection starts.

- 11** Check the LEDs of the sensors.

When the mode is successfully changed, the LEDs of the sensors light.

- Pedaling monitor: Lights green for 10 seconds
- Dual power: Lights orange for 10 seconds
- Single power: Flashes orange for 10 seconds

If [Success] is not displayed

- Timeout: Communication conditions are poor.
Check that the sensors to be connected are running and then bring the device near to the sensors and perform the connection operation again. If the problem is still not resolved, move sufficiently away from devices such as a Wi-Fi or other wireless LAN device, or a microwave oven, and then try the connection operation again.
- Battery has run out of power: The battery power is consumed.
Remove the battery and replace it with a new one.

Magnet calibration

Magnet calibration is an important task to ensure that the pedaling monitor sensors can detect and accurately measure the magnet positions.

Be sure to perform this task when mounting the pedaling monitor sensors and after replacing the magnet.

Note

- We recommend that the place of purchase perform magnet calibration.

- 1** Ensure the bike is horizontal by using rollers or the like so that the heights of the front and back wheels are the same.
- 2** Press the [Menu] button.
- 3** Use the [←]/[→] buttons to select [Bike] and then press the [Confirm] button.

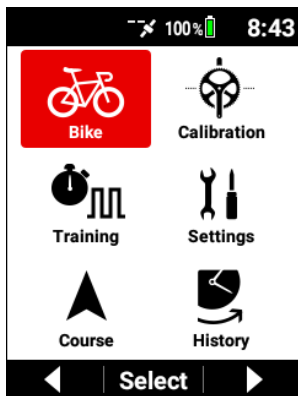

- 4** Use the [←]/[→] buttons to select [Tools] and then press the [Confirm] button.

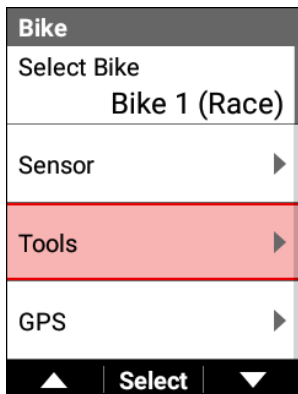

- 5** Use the [←]/[→] buttons to select [Pedaling Settings] and then press the [Confirm] button.

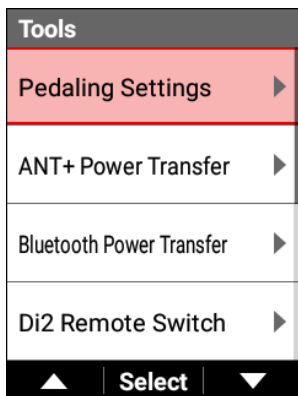

- 6** Use the [←]/[→] buttons to select [Magnet Calibration] and then press the [Confirm] button.

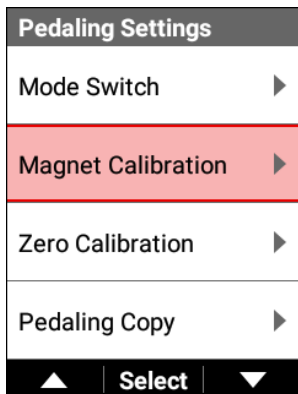

- 7** Turn the crank slowly in the normal direction and check that the counter is incremented once for every turn, by one count at a time.

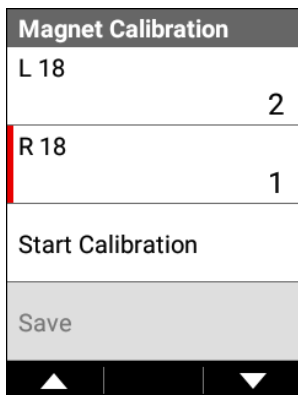

If the counter is not incremented, readjust the magnet position.

- 8** Use the [←]/[→] buttons to select [Start Calibration] and then press the [Confirm] button.

Magnet Calibration	
L 18	2
R 18	1
Start Calibration	
Save	
▲	Select ▼

- 9** Turn the crank slowly in the normal direction at a speed of about 30 rpm until the counter reaches 5/5.

Magnet Calibration	
L 18	5 / 5
R 18	5 / 5
Start Calibration	
Save	
▲	Select ▼

- 10** Use the [←]/[→] buttons to select [Save] and then press the [Confirm] button.

Magnet Calibration	
L 18	5 / 5
R 18	5 / 5
Start Calibration	
Save	
▲	Select ▼

- 11** Check that "Success" is displayed and then press the [Confirm] button.

Magnet Calibration	
Notification	
Success	
OK	

Pedal copying

This is enabled only in the pedaling monitor mode.

If, for example, one of the sensors has failed or the battery has run out of power, values can be displayed on the device and recorded as log data by copying the values of the pedaling monitor on the other side.

This enables your training to be recorded even in an emergency.

- 1 Press the [Menu] button.**
- 2 Use the [←]/[→] buttons to select [Bike] and then press the [Confirm] button.**

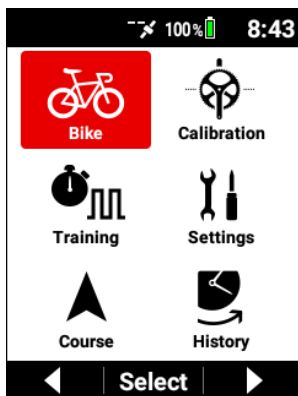

- 3** Use the [←]/[→] buttons to select [Tools] and then press the [Confirm] button.

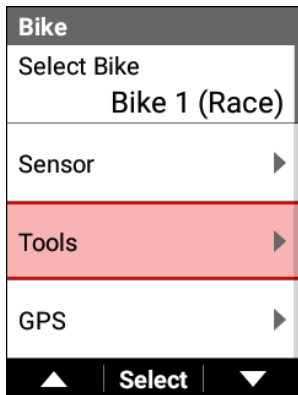

- 4** Use the [←]/[→] buttons to select [Pedaling Settings] and then press the [Confirm] button.

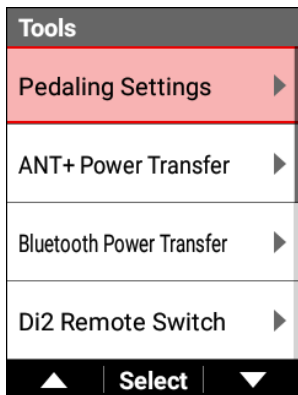

- 5 Use the [←]/[→] buttons to select [Pedaling Copy] and then press the [Confirm] button.

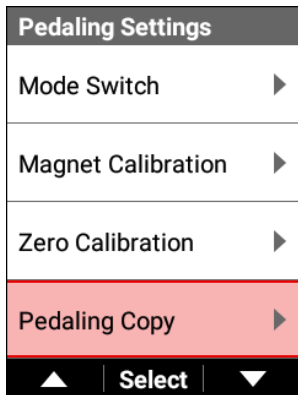

- 6 Use the [←]/[→] buttons to select the copy method and then press the [Confirm] button.

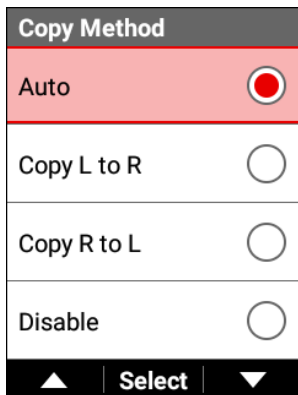

Select from [Auto]*, [Copy L to R], [Copy R to L], and [Disable].

If [Auto] is selected, the power values of the side for which the connection is enabled are automatically reflected as the power values on the side for which the connection is disconnected.

*: Factory default setting

- 7 Use the [←]/[→] buttons to select [L : R Balance] and then press the [Confirm] button.**

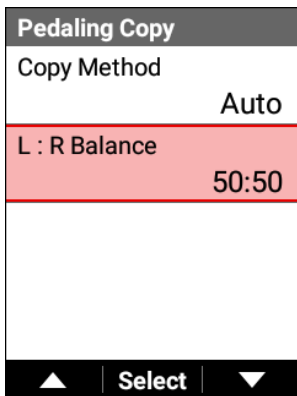

- Use the [←]/[→] buttons to enter the left/right balance (%) and then press the [Confirm] button.

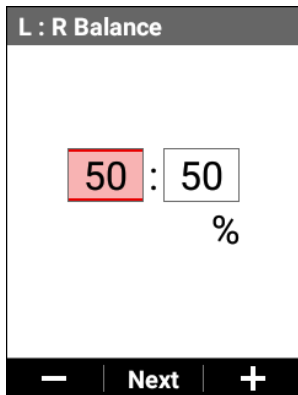

Be careful because correct power display will not be possible if you mix up the left and right when setting this.

■ Auto Zero Point Calibration

You can set zero point calibration to be performed automatically before the device enters sleep mode when the crank arm is placed vertical to the ground after the bike has been ridden for at least 20 minutes in an environment with a stable temperature before stopping.

This allows you to significantly reduce the frequency of performing zero point calibration before training.

- Press the [Menu] button.

- 2 Use the [←]/[→] buttons to select [Bike] and then press the [Confirm] button.

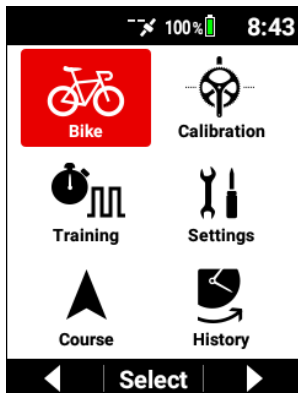

- 3 Use the [←]/[→] buttons to select [Sensor] and then press the [Confirm] button.

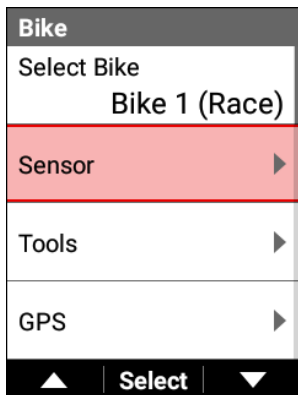

- 4 Use the [←]/[→] buttons to select the sensor name and then press the [Confirm] button.

Sensor
Add Sensor
Pedaling Monitor L Connected #18
Pedaling Monitor R Connected #18
ANT+Power Meter Searching #1

▲ | Select | ▼

- 5 Use the [←]/[→] buttons to select [Auto Zero Calibration] and then press the [Confirm] button.

If the check box is selected, the Auto Zero Point Calibration function is enabled.

Pedaling Monitor L
Battery 2.9 V, Good
Manufacture ID 48
Force Preview ▶
Auto Zero Calibration ▶

▲ | Select | ▼

■ Torque Assistance

You can finely adjust the torque value measured with the pedaling monitor sensors.

- 1 Press the [Menu] button.**
- 2 Use the [←]/[→] buttons to select [Bike] and then press the [Confirm] button.**

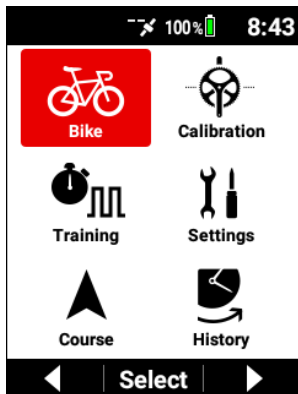

- 3 Use the [←]/[→] buttons to select [Sensor] and then press the [Confirm] button.

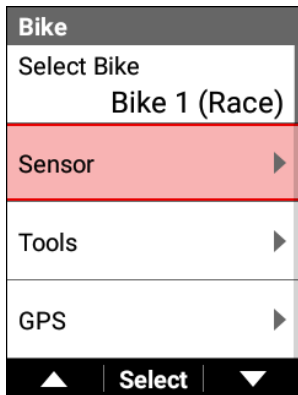

- 4 Use the [←]/[→] buttons to select the sensor name and then press the [Confirm] button.

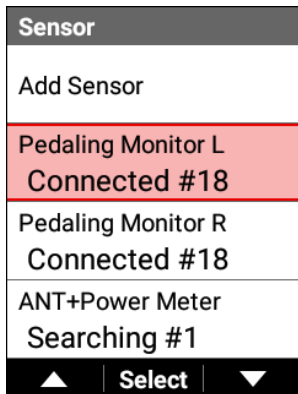

- 5 Use the [←]/[→] buttons to select [Torque Adjustment] and then press the [Confirm] button.

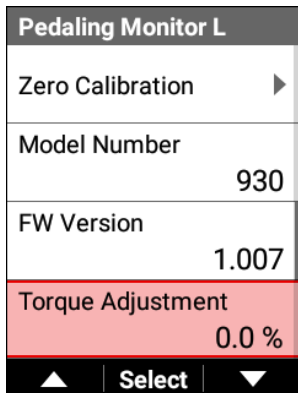

- 6 Use the [←]/[→] buttons to set the torque adjustment value and then press the [Confirm] button.

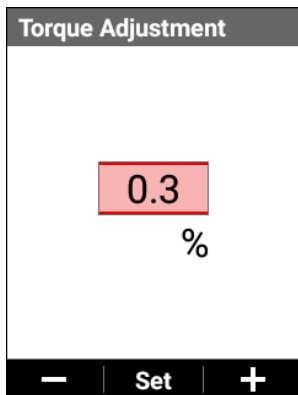

Adjustment within the range of -10% to +10% is possible.

7 Check the torque adjustment value.

■ Sprint Detection

If you enable sprint detection, sprinting will be detected when the intensity of MMP 10 seconds or MMP 30 seconds exceeds 90%, and the device will begin recording riding data for 1 minute before and after at a 0.5-second interval, which is double the normal frequency.

The mean maximal power of 10 seconds or 30 seconds is displayed when sprinting is detected.

The saved data can be checked in the PC version of Cyclo-Sphere.

1 Press the [Menu] button.

2 Use the [←]/[→] buttons to select [Settings] and then press the [Confirm] button.

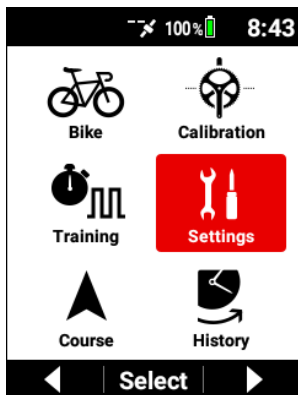

- 3** Use the [←]/[→] buttons to select [Logging] and then press the [Confirm] button.

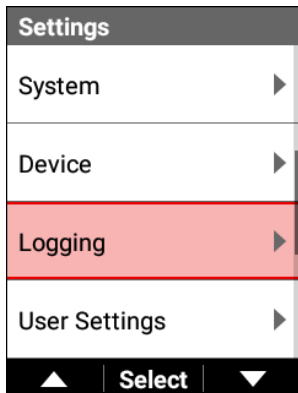

- 4** Use the [←]/[→] buttons to select [Sprint Detection] and then press the [Confirm] button.

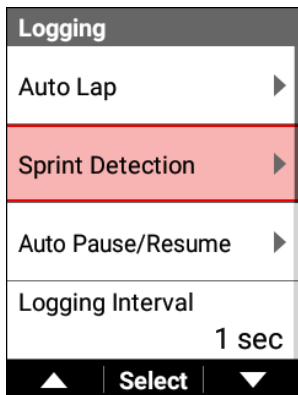

- 5 Use the [←]/[→] buttons to select [Enable] and then press the [Confirm] button.

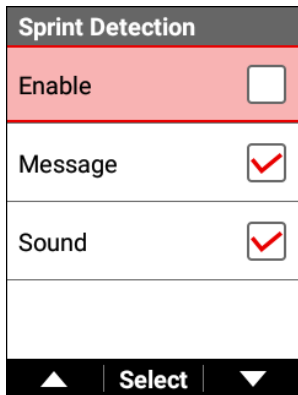

- 6 Check the message and then press the [Confirm] button.

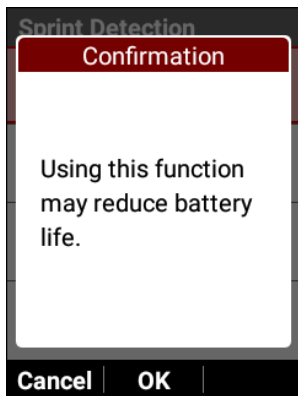

Sprint Detection	
Enable	<input checked="" type="checkbox"/>
Message	<input checked="" type="checkbox"/>
Sound	<input checked="" type="checkbox"/>
▲ Select ▼	

Sprint detection is enabled.

To be notified when sprinting is detected, select the [Sound] check box and/or [Message] check box.

Note

- If the firmware of the SGY-PM910 series pedaling monitor sensor is not up to date, the “Software does not support this function. Please update sensors.” message appears. The firmware update of the SGY-PM910 series pedaling monitor sensor cannot be performed on the device. Cyclocomputer SGX-CA500 is required.

Zero Point Calibration

Perform zero point calibration of the pedaling monitor sensor.

Aim to perform this once every month and when the air temperature changes by at least 4°C.

- 1** Fix the bike in place using rollers or the like.

- 2** Turn the crankset of the bike at least three times to start the left and right transmitters.

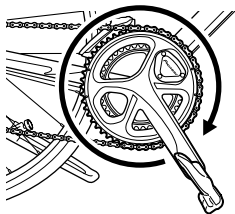

- 3** Stop the crank arm in the vertical position.

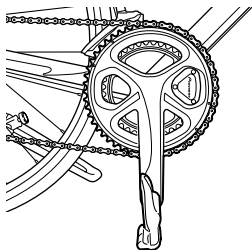

- 4** Press the [Menu] button.

- 5 Use the [←]/[→] buttons to select [Calibration] and then press the [Confirm] button.

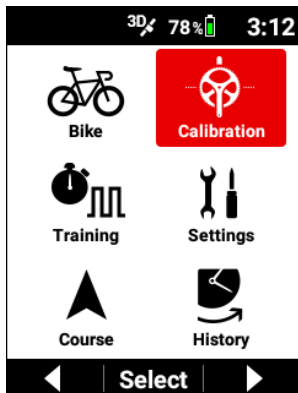

- 6 Use the [←]/[→] buttons to select [LR Zero Calibration], [Left Zero Calibration] or [Right Zero Calibration], and then press the [Confirm] button.

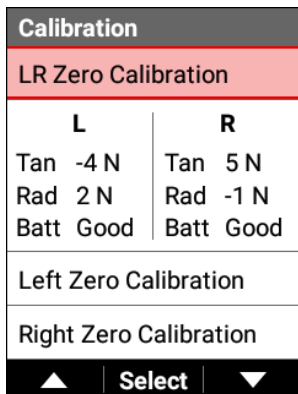

Calibration starts.

If you select [LR Zero Calibration], calibration is performed for both the left and right pedaling monitor sensors.

Calibration is performed even if only one of the left and right sides is connected.

- 7** Check that "Success" is displayed and then press the [Confirm] button.



If "Failure" is displayed, calibration may have been performed when the crank is in an unstable state such as when it was moving. Perform zero point calibration again when the crank is still.

8 Check the calibration results.

Calibration			
LR Zero Calibration			
	L		R
Tan	-4 N	Tan	5 N
Rad	2 N	Rad	-1 N
Batt	Good	Batt	Good
Left Zero Calibration			
Right Zero Calibration			
▲	Select	▼	

Tangential force: Check that the force is within the range of 0 ± 3 N.

Radial force: Check that within the range of 0 ± 3 N.

Battery: Check the battery level and status.

New: New battery

Good: Good state

OK: Normal

Low: Low

Critical: Cannot be used

Note

- If a value is outside of the range, zero point calibration may have been performed when the crank is in an unstable state such as when it was moving.
Perform zero point calibration again when the crank is still.
- If the battery status is low or critical, replace the batteries of the both the left and right sensors at the same time.

Bike and Sensor Settings

Changing the Bike

Change the bike to use.

- 1** Press the [Menu] button.
- 2** Use the [←]/[→] buttons to select [Bike] and then press the [Confirm] button.

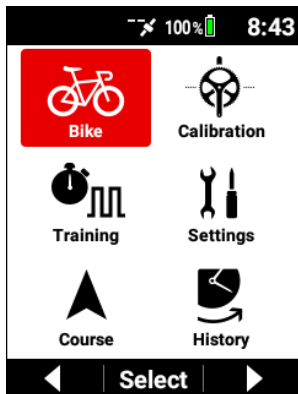

- 3** Use the [←]/[→] buttons to select [Select Bike] and then press the [Confirm] button.

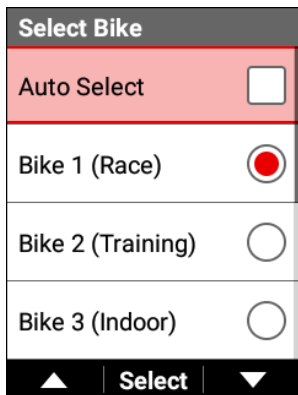
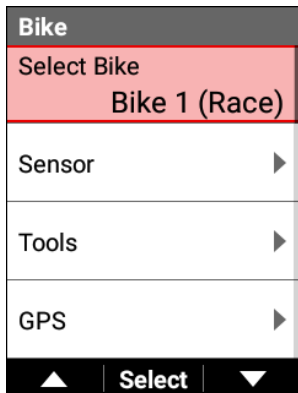

Setting item	Description
Auto Select	Enable or disable* the function to automatically change the bike selection.

Note

- If you enable auto selection, the device searches the pedaling monitor sensors, power meters, and smart trainers registered to multiple bikes, and automatically changes the bike to the one that includes the most connectable sensors.
When changing is completed, you are notified by a message and sound.
- The bike is not switched automatically even if auto select is enabled on the bike selection screen.
- Even if there are valid sensors nearby, switching the bike may take longer than one minute.
- When the bike is changed, the device also automatically switches to the registered sensor settings, GPS settings, display settings, sound settings, and other settings, regardless of whether the bike was changed automatically or manually.
Check that the sensors are connected correctly to the device when the bike is changed.

Connecting Sensors

You can connect commercially available ANT+ sensors and Bluetooth heart rate sensors to this device.

Mount the sensors to the bike and then check that they are running before you begin to connect them.

Refer to the user's guide of your sensors for mounting instructions.

The following sensors can be added.

- ANT+ speed sensor
- ANT+ cadence sensor
- ANT+ speed & cadence sensor
- ANT+/Bluetooth heart rate sensor
- ANT+ power meter
- Left pedaling monitor
- Right pedaling monitor
- Shimano Di2
- ANT+ shifter

- ANT+ smart trainer (ANT+FE-C)
- ANT+ Bicycle Lights

Note

- When using the optional ANT+speed sensor or ANT+speed & cadence sensor, please set the tire circumference.
The tire circumference can be changed in [Menu] - [Bike] - [Wheel Circumference].
It is set to 2,096 mm by default.
- To connect to the Bluetooth heart rate sensor, configuration of the Bluetooth setting on the device is required.

■ Adding a Sensor

A search for all nearby connectable sensors is performed and the found sensors are listed as connection candidates.

- 1 Press the [Menu] button.**
- 2 Use the [←]/[→] buttons to select [Bike] and then press the [Confirm] button.**



- 3** Use the [←]/[→] buttons to select [Sensor] and then press the [Confirm] button.

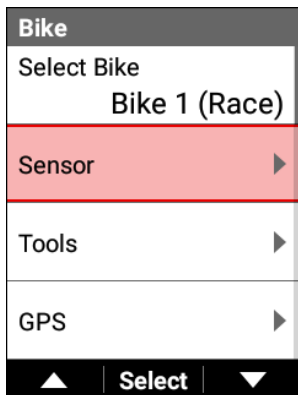

- 4** Use the [←]/[→] buttons to select [Add Sensor] and then press the [Confirm] button.

The "Searching" message appears and then a list of sensors that can be connected appears.

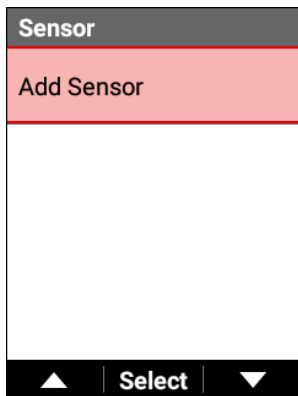

When the Bluetooth heartbeat sensor is connected, the connection of the Bluetooth heartbeat sensor is temporarily disconnected.

- 5 Use the [←]/[→] buttons to select the check box of the sensor you wish to connect.**

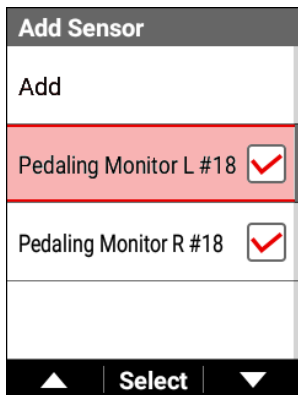

The sensors with check boxes selected are added to the sensor list. Clear the check mark for any sensor that does not need to be added to the sensor list in advance.

- 6** Use the [←]/[→] buttons to select [Add] and then press the [Confirm] button.

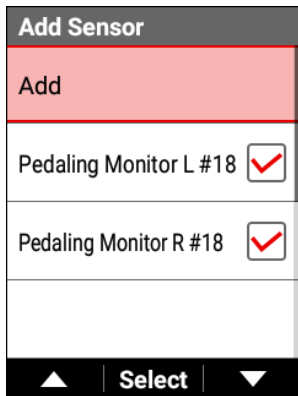

Note

- Only one of each type of sensor can be added.
- ANT+S&C (speed and cadence) sensor can not be connected when ANT+speed sensor or ANT+cadence sensor is connected.
- If a Bluetooth heart rate sensor is connected, you cannot connect an ANT+ heart rate sensor.
- Pairing is required for a Bluetooth heart rate sensor. A connection with this device is not possible while paired with ZWIFT, etc. When connected with this device, a connection with ZWIFT is not possible. If you wish to display and record a heart rate sensor for both, use an ANT+ heart rate sensor for one of the connections.
- Priorities are set for cadence values in the order of pedaling monitor sensor, ANT+cadence sensor, ANT+S&C (speed and cadence) sensor, ANT+power meter.
- If the same type of sensor is already connected, it will be deleted from the sensor list automatically and the newly added sensor will be added to the sensor list.
- When a sensor search is performed, it may take longer than one minute.

- If an ANT+power meter is added or enabled when the ANT+power transmission function is enabled, the "When this function is enabled, ANT+ Power Transfer will be disabled. OK?" message appears and the ANT+power transmission function is disabled.

■ Checking the Settings of Added Sensors

You can check the settings for each added sensor.

A sensor can also be deleted.

- 1 Press the [Menu] button.**
- 2 Use the [←]/[→] buttons to select [Bike] and then press the [Confirm] button.**

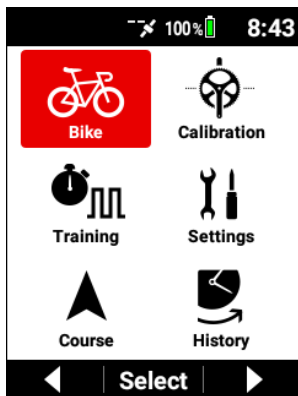

- 3** Use the [←]/[→] buttons to select [Sensor] and then press the [Confirm] button.

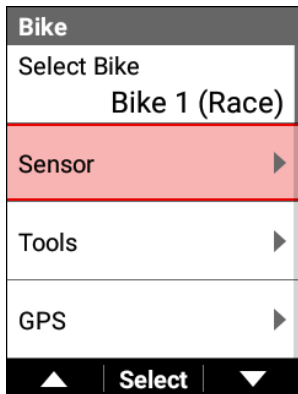

- 4** Use the [←]/[→] buttons to select the name of the sensor for which you wish to check the settings or you wish to delete and then press the [Confirm] button.

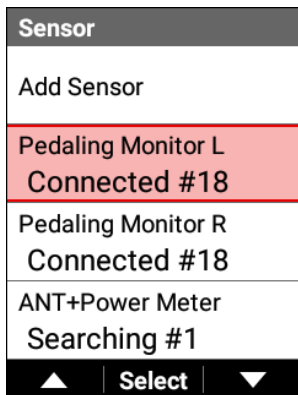

Setting item	Description
Enable	Enable or disable the sensor.
Sensor Name	Enter the sensor name.
Status	Display the searching, connected, and disabled statuses.
Device Number	Display the device number of the sensor.
Battery	<p>Display the voltage value or battery status.</p> <ul style="list-style-type: none"> • New: New battery • Good: Good state • OK: Normal • Low: Low • Critical: Cannot be used <p>“--” is displayed when the sensor is not supported or before the measurement data of the status is received. This item is not displayed for a sensor that does not support display.</p>
Manufacture ID	<p>Display the manufacturer ID or name of the sensor. This item is not displayed for a sensor that does not support display.</p>
Delete	Delete this sensor from the sensor list.

When ANT+power meter is connected

Setting item	Description
Zero Calibration	<p>Perform zero point calibration. The status, result, and data are displayed. When a ANT+power meter that supports auto zero point calibration is connected, the auto zero point check box can be selected. The torque values are displayed for a ANT+power meter that supports torque value display.</p>
Balance Setting	<p>Select this check box to enable the balance settings. Enter the left/right balance. Select the left sensor or right sensor for the sensor type. A power value that is double on the sensor side is corrected from the entered left/right balance and sensor type.</p>

Slope	Set this when a CTF type ANT+power meter is connected. The values received from the ANT+power meter are displayed or the set values are sent to the ANT+power meter.
-------	---

ANT+ shifter

The battery states are displayed for electric powered components compatible with SRAM eTap™ and other ANT+ shifters.

They are displayed when the information of supported items is received.

"--" is displayed for items when searching and before the data is received.

Setting item	Description
Front Derailleur	Display the battery level and status of the front derailleur.
Rear Derailleur	Display the battery level and status of the rear derailleur.
L Shifter	Display the battery level and status of the left shifter.
R Shifter	Display the battery level and status of the right shifter.
System Derailleur	Display the battery level and status of the system derailleur.

ANT+ smart trainer

If you connect a ANT+smart trainer that supports load control, you can link the load with training and simulation functions.

Setting item	Description
Training Link	Select this check box to link the target power value during training to the load of the ANT+smart trainer.
Simulation Link	Select this check box to link the current gradient during course simulation to the load of the ANT+smart trainer.
Load Setting	Select the load type from [Power], [Grade], and [Disable]. You can send the set power value or gradient value to a ANT+smart trainer to adjust the load manually.

Each of the set values is sent to the ANT+smart trainer.

Shimano Di2 D-FLY

Setting item	Description
Front Adjustment	Display the adjustment value of the front derailleur.
Rear Adjustment	Display the adjustment value of the rear derailleur.

When the rear derailleur is shifted to the lowest gear while the front derailleur is at the inner position, you will be alerted by the “Di2 Shift End” message and a sound.

When synchronized shifting is selected for the connected Shimano Di2, you will be alerted by the “Di2 Synchronized Shift” message and a sound at the timing that the front derailleur is next shifted by shifting the rear derailleur.

ANT+ Bike Lights

Control the lighting and display the remaining battery power of the front lights and tail lights that support ANT+Bike Lights.

You can add up to four nearby supported lights by adding sensors.

The light numbers L1 to L4 are assigned automatically to the added lights.

The light number, light type, and connection status is displayed in the sensor information.

- Light type
Head light, tail light, etc. is displayed as the light type supported for each light.
- Connection status
The “Connected (#/N)” status indicates the number of lights connected (#) out of the total number of added lights (N).

Sensor
ANT+Power Meter Searching #1000
Shimano Di2 Searching #7538
ANT+Bike Lights Connected (1/1)

▲ | Select | ▼

Set the on/off timing for the Auto Light Type.

Setting item	Description
--------------	-------------

Logging interlocking	Turn on the lights when logging starts and turn off the lights when the log data is saved.
Cycle Computer interlocking	Turn on the lights when connecting with the lights completes after the device is turned on, and turn off the lights when the device is turned off.

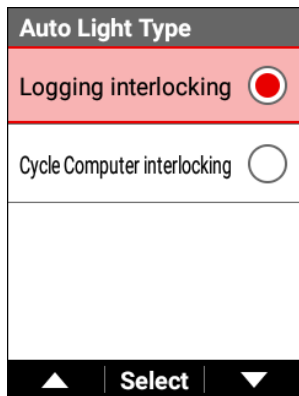

You can confirm the status and set the lighting pattern for each added light.

L1 Headlight	
Sensor Name	#50705
Status	Connected
Device Number	50705
Battery	OK
▲ Select ▼	

- **Lighting pattern setting**
 Set the lighting pattern of each light for the daytime mode and nighttime mode, respectively.
 Daytime mode is the period from 30 minutes after sunrise to 30 minutes before sunset.
 Nighttime mode is the period from 30 minutes before sunset to 30 minutes after sunrise.
 Lighting patterns can be selected from the modes supported by each light.

Daytime Mode	
OFF	<input type="radio"/>
Light up 1	<input checked="" type="radio"/>
Light up 2	<input type="radio"/>
Light up 3	<input type="radio"/>
▲ Select ▼	

- Delete
The connected lights can be deleted individually.

Note

- If the remaining battery power of a light becomes low, an alert sounds and a message appears.
The message displays the light number, light type, and battery level.
- Each remaining battery power can be displayed in a data field.
The light number and light status are displayed in a sub-label.
- If multiple lights are connected, the status of lights that run out of battery power will be displayed as "Searching."
If a total of eight ANT sensors are connected, even if a light that runs out of battery power is charged, it may not be able to connect to the device.
Reconnect the light by adding a sensor again, or turn the device to sleep once.
- Due to the specifications of ANT+Bicycle Lights connected to the device, lights may turn off or the lighting mode may change unexpectedly.
If the battery power of the device runs out, or if ANT+Bicycle Lights are disconnected when the device moves away from the lights, etc., the lights will turn off automatically.
If some of the connected lights run out of battery power, the lights may turn off temporarily during reconnection of the remaining lights to the device.
Please exercise caution when using this function.
Pioneer will not be held responsible for any injury or damage due to accidents or any other phenomenon that may occur while using this function.

ANT+ Power Transmission Function Settings

Enable this function to transmit the received power values of the Pedaling Monitor sensors as power values of an ANT+ power meter.

This enables power values or cadence values to be transmitted to, for example, the ZWIFT PC application, a Smart Trainer, or another manufacturer's cycle computer. Additionally, when the pedaling monitor sensor is not connected, activating [Virtual Power] in [Virtual Settings] sends the calculated Virtual Power value as an ANT+ power meter.

If you enable this function, the connection of an ANT+ power meter will be disabled.

When connecting this device with ZWIFT using ANT+ power transmission, connect with the device number of this device as an ANT+ power meter in the sensor connection screen of ZWIFT.

Then, connect with the device number of this device as cadence in the ZWIFT screen.

- 1 Press the [Menu] button.**
- 2 Use the [←]/[→] buttons to select [Bike] and then press the [Confirm] button.**

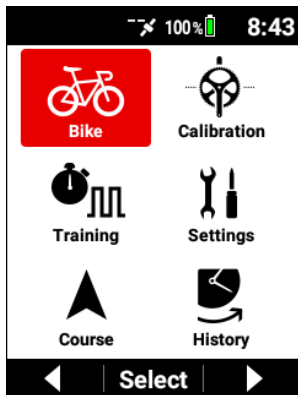

- 3** Use the [←]/[→] buttons to select [Tools] and then press the [Confirm] button.

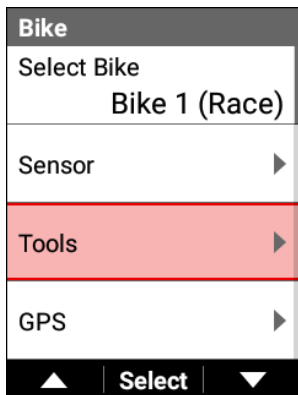

- 4** Use the [←]/[→] buttons to select [ANT+ Power Transfer] and then press the [Confirm] button.

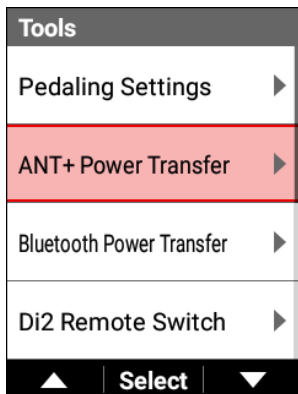

ANT+ Power Transfer	
Enable	<input checked="" type="checkbox"/>
Device Number	11
<div style="display: flex; justify-content: space-between; align-items: center;"> ▲ Select ▼ </div>	

Setting item	Description
Enable	Enable or disable the ANT+ Power Transmission function.
Device Number	Generate the device number of the ANT+ power meter to transmit from the serial number of this device.

Bluetooth Power Transmission Function Settings

Enable this function to transmit the received power values of the pedaling monitor sensors or the power values of the ANT+ power meter as power values of the Bluetooth power meter.

This enables power values to be transmitted to, for example, the ZWIFT app. If both the pedaling monitor sensors and ANT+ power meter are connected, priority is given to the pedaling monitor sensors.

When a Pedaling Monitor or ANT+ Power Meter are not connected, activating [Virtual Power] in [Virtual Settings] sends the calculated Virtual Power value as a Bluetooth power meter.

Configuration of the Bluetooth setting on the device is required.

When connecting this device with ZWIFT using the Bluetooth power transmission function, select the power meter in the device connection screen of ZWIFT and select the device name of this device which begins with "P-" from the device list displayed when searching.

Then, in the same way select the device name of this device as the cadence source.

The device beginning with Pioneer-R***** or Pioneer-L***** in the device list displayed when searching is the Bluetooth power meter of the pedaling monitor sensor.

The power value will be 0 W during operation in the pedaling monitor mode.

Do not select this when connecting using the Bluetooth power transmission function of the device.

If the power value of ZWIFT is not displayed, searching begins frequently, and the “Start the Cyclo-Sphere Control app before Bluetooth Power Transfer connection.” message appears on the device, start the Cyclo-Sphere Control App, display the device list, and set the status of the device to “Connected”
If “Connected” cannot be set, check the following.

Bluetooth Setting

- 1 Press the [Menu] button.**
- 2 Use the [←]/[→] buttons to select [Bike] and then press the [Confirm] button.**



- 3** Use the [←]/[→] buttons to select [Tools] and then press the [Confirm] button.

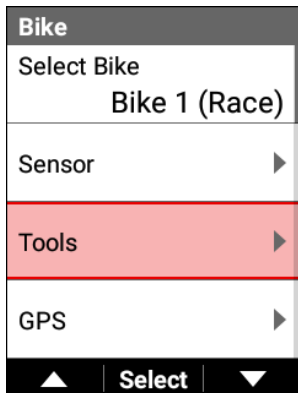

- 4** Use the [←]/[→] buttons to select [Bluetooth Power Transfer] and then press the [Confirm] button.

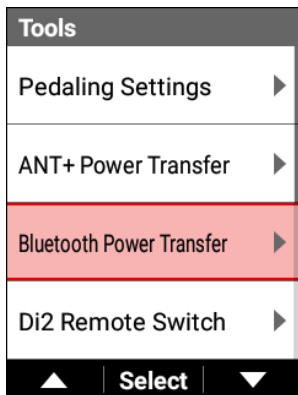

Bluetooth Power Transfer	
Enable	<input type="checkbox"/>
Device Name	P-000113
▲ Select ▼	

Setting item	Description
Enable	Enable or disable the Bluetooth Power Transmission function.
Device Name	Generate the device name of the Bluetooth power to transmit from the serial number of this device.

Virtual Settings

Set parameters for calculating virtual power and virtual CdA. These settings are saved and linked to the selected bike profile.

- 1 Press the [Menu] button.**

- 2 Use the [←]/[→] buttons to select [Bike] and then press the [Confirm] button.

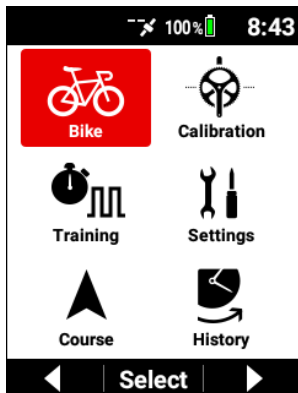

- 3 Use the [←]/[→] buttons to select [Tools] and then press the [Confirm] button.

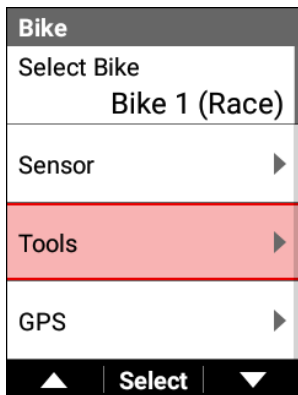

- 4 Use the [←]/[→] buttons to select [Virtual Settings] and then press the [Confirm] button.

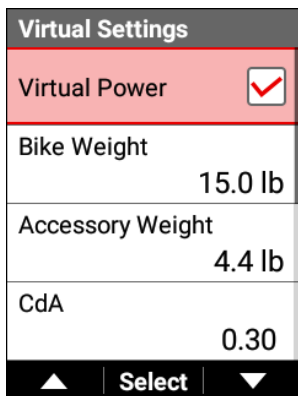
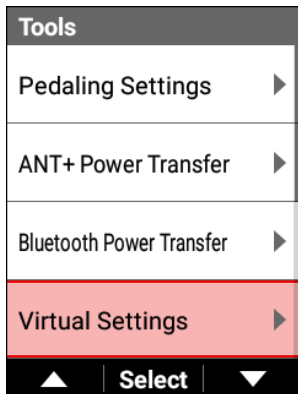

Setting item	Description
Virtual Power	Enable or disable. This is set to enable by default.
Bike Weight	Enter the weight of the bike. Enter user weight in [User Edit]. This is set to 15.0 lb or 6.8 kg by default.
Accessory Weight	Enter the total weight of helmet, shoes, clothing, etc. This is set to 4.4 lb or 2.0 kg by default.
CdA	Enter numerical values. The default value of 0.35 is the value for riding in a standard position. This might be adjusted to 0.2, for example, when riding using an aerodynamically efficient stance, or 0.4 for a more relaxed style.
Crr	Enter the coefficient matched to the tire width and road surface. This is set to 0.004 by default.
Fixed Wind Direction	When wind information cannot be acquired automatically using the "Cyclo-Sphere Control App", the setting values entered become active. One of 8 directions can be chosen for wind direction. This is set to North by default.
Fixed Wind Speed	Enter the value to be used when wind information cannot be acquired automatically. This is set to 0 mph or 0 m/s by default.

Note

- Pressing and holding the [Confirm] button for 2 seconds or longer on the meter screen to configure [Virtual Settings] from the status screen that appears.

Di2 Remote Switch Setting

When components compatible with the remote switches of Shimano Di2 D-FLY are connected, assign the operations of the left and right remote switches to the functions of this device or an external sensor control.

- 1 Press the [Menu] button.**

- 2 Use the [←]/[→] buttons to select [Bike] and then press the [Confirm] button.

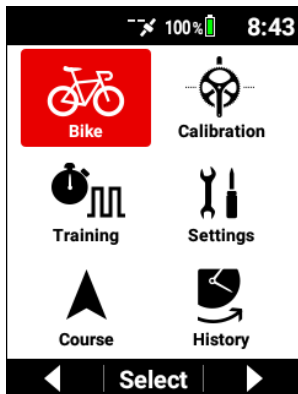

- 3 Use the [←]/[→] buttons to select [Tools] and then press the [Confirm] button.

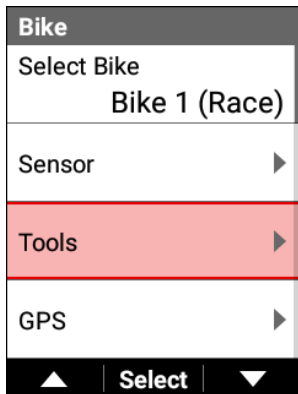

- 4 Use the [←]/[→] buttons to select [Di2 Remote Switch] and then press the [Confirm] button.

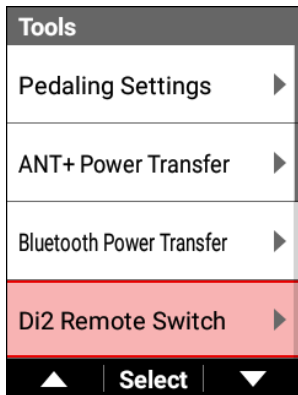

Setting item	Description
Single Click Right/ Single Click Left/Long Press Right/Long Press Left	Select from [Logging Start / Stop], [Lap], [Scroll to the Right], [Scroll to the Left], [Press Menu Button], [Press and Hold Menu Button], [Zero Calibration], [Capture], and [Disable].

Note

- Zero point calibration is performed for the connected pedaling monitor sensors or ANT+ power meter.
If both the pedaling monitor sensors and ANT+ power meter are connected, priority is given to the pedaling monitor sensors.

Speed Priority Level Settings

Set the priority level of sensors for displaying and recording speed values. Select from ANT+speed sensor, ANT+S&C sensor, ANT+power meter, ANT+smart trainer, and GPS speed for priority levels 1 to 4.

- 1 Press the [Menu] button.**
- 2 Use the [←]/[→] buttons to select [Bike] and then press the [Confirm] button.**

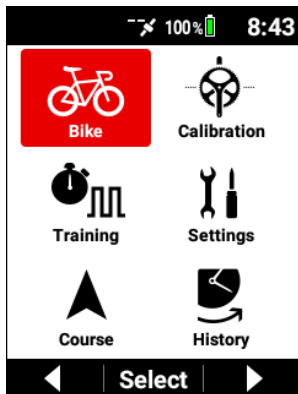

- 3** Use the [←]/[→] buttons to select [Tools] and then press the [Confirm] button.

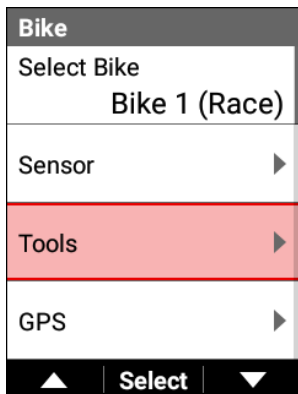

- 4** Use the [←]/[→] buttons to select [Speed Priority] and then press the [Confirm] button.

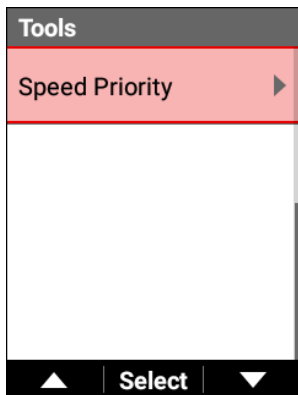

- 5 Use the [←]/[→] buttons to select one of [Speed Priority1] to [Speed Priority4] and then press the [Confirm] button.

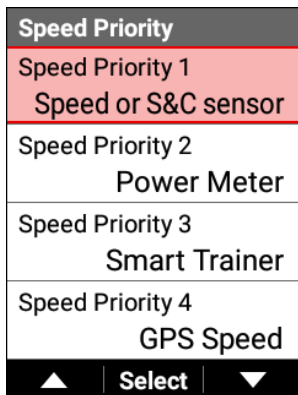

- 6 Use the [←]/[→] buttons to select the item you wish to set for the speed priority level and then press the [Confirm] button.

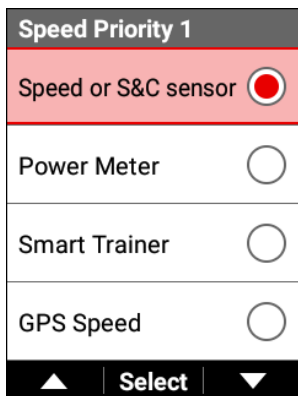

GPS Setup

Configure the settings related to the GPS function.
The settings are saved linked to the selected bike.

- 1 Press the [Menu] button.**
- 2 Use the [←]/[→] buttons to select [Bike] and then press the [Confirm] button.**

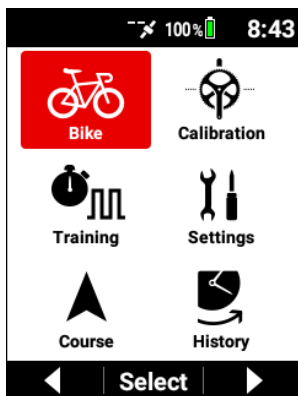

- 3** Use the [←]/[→] buttons to select [GPS] and then press the [Confirm] button.

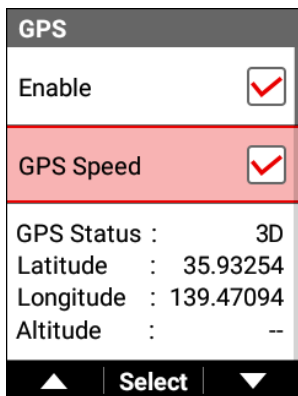
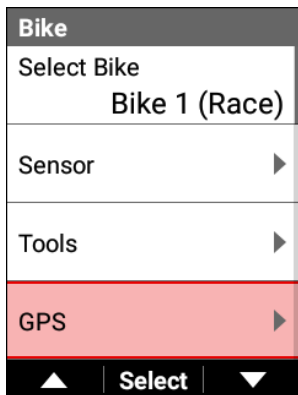

Setting item	Description
--------------	-------------

Enable	<p>Enable* or disable the GPS function.</p> <p>You can enable GPS also in the status display by pressing and holding the [Confirm] button for 2 seconds or more from the meter screen.</p>
GPS Speed	<p>Enable* or disable the GPS speed function.</p> <p>Select this check box to display the speed at which the GPS information was obtained.</p> <p>This can be selected only when GPS is enabled.</p> <p>Errors may be generated between the displayed values and actual positions depending on the signal conditions.</p>
GPS Status	<p>Display the GPS positioning status (OFF/2D/3D).</p> <p>Furthermore, the satellites for which signals were captured are indicated by a number (#), and the satellite numbers with an + mark were those used for GPS positioning.</p>

*: Factory default setting

Display Settings

Configure the settings related to the display.
The settings are saved linked to the selected bike.

1 Press the [Menu] button.

- 2** Use the [←]/[→] buttons to select [Bike] and then press the [Confirm] button.

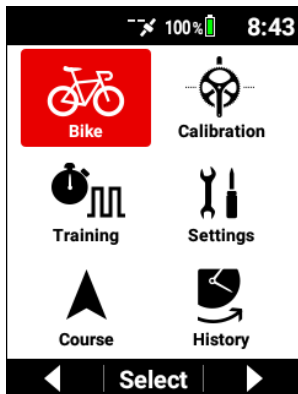

- 3** Use the [←]/[→] buttons to select [Display] and then press the [Confirm] button.

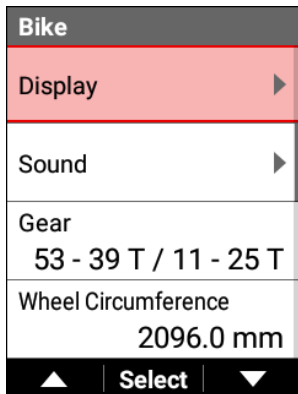

Display	
Brightness	5
Back Light Timer	Always On
<div style="display: flex; justify-content: space-between; align-items: center;"> ▲ Select ▼ </div>	

Setting item	Description
Brightness	Adjust the brightness for when the backlight is on to any of 11 levels (3*). You can set the screen brightness also in the status display by pressing and holding the [Confirm] button for 2 seconds or more from the meter screen.
Back Light Timer	Switch the backlight lighting duration to [Always On]*, [15 sec], [30 sec] or [1 min]. When other than [Always On] is selected, the backlight turns off after the selected time elapses after the last operation is performed on the device.

*: Factory default setting

Sound Settings

Configure the settings related to sound.

The settings are saved linked to the selected bike.

1 Press the [Menu] button.

- 2** Use the [←]/[→] buttons to select [Bike] and then press the [Confirm] button.

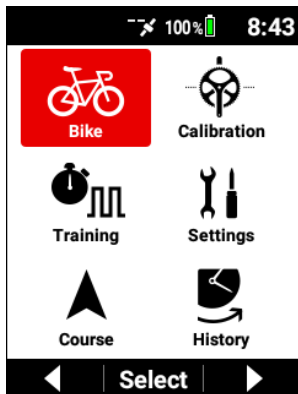

- 3** Use the [←]/[→] buttons to select [Sound] and then press the [Confirm] button.

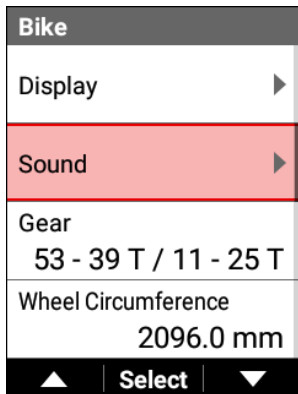

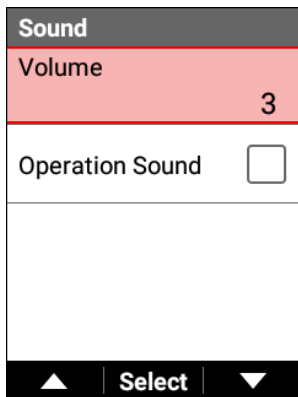

Setting item	Description
Volume	Adjust the volume of the device speaker to any of 6 levels (3*).
Operation Sound	Enable or disable* the sound that is output when a button is pressed.

*: Factory default setting

Gear Settings

Configure the settings related to Gear.

- 1** Press the [Menu] button.

- 2** Use the [←]/[→] buttons to select [Bike] and then press the [Confirm] button.

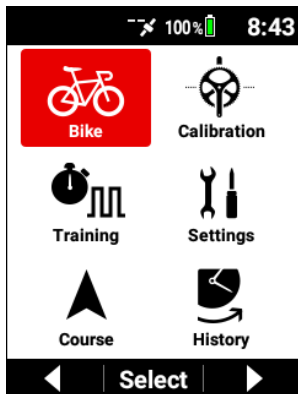

- 3** Use the [←]/[→] buttons to select [Gear] and then press the [Confirm] button.

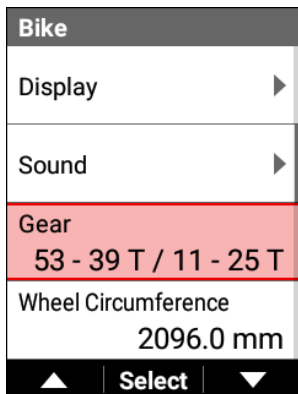

Gear	
Sprockets Model	11-speed
Chainrings Type	53 - 39 T
Sprockets Type	11 - 25 T
<div style="display: flex; justify-content: space-between; align-items: center;"> ▲ Select ▼ </div>	

Setting item	Description
Sprockets Model	Select Sprockets Model.
Chainrings Type	When Outer Side of Chainrings Type is selected, Inner Side will automatically be selected. To change this setting, adjust the number of teeth for each gear from Gear Combinations.
Sprockets Type	Select the number of teeth for Top and Low of Sprockets Type. Adjust the number of teeth for each gear from Gear Combinations.

Bike Distance and Time Settings

Set the total bike distance and total bike time.
The settings are saved linked to the selected bike.

- 1 Press the [Menu] button.**

- 2 Use the [←]/[→] buttons to select [Bike] and then press the [Confirm] button.

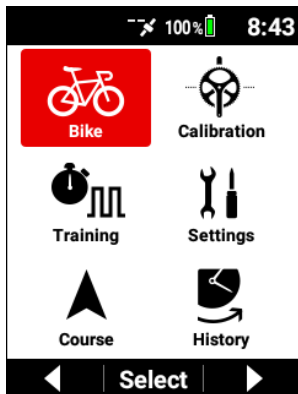

- 3 Use the [←]/[→] buttons to select [Bike Distance] and then press the [Confirm] button.

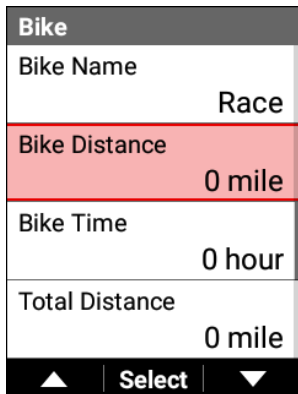

- 4 Use the [←]/[→] buttons to enter the total bike distance and then press the [Confirm] button.

Bike Distance

0	0	0	0	0	0
---	---	---	---	---	---

mile

— | Next | +

Each press of the [Confirm] button moves the cursor to the next digit place down.

If you press the [Confirm] button after the cursor has been moved to the ones place, the numerical value is confirmed and the previous screen reappears.

- 5 Use the [←]/[→] buttons to select [Bike Time] and then press the [Confirm] button.

Bike	
Bike Name	Race
Bike Distance	0 mile
Bike Time	0 hour
Total Distance	0 mile

▲ | Select | ▼

- 6 Use the [←]/[→] buttons to enter the total bike time and then press the [Confirm] button.

Bike Time					
0	0	0	0	0	0
hour					

— | Next | +

Each press of the [Confirm] button moves the cursor to the next digit place down.

If you press the [Confirm] button after the cursor has been moved to the ones place, the numerical value is confirmed and the previous screen reappears.

Advanced Settings

Note

- Configuration of the settings is simpler if you use the Cyclo-Sphere Control App, which is an app for smartphones. The settings can be automatically synchronized with the device. For details, refer to the following website.
<https://cyclo-sphere.com/app/>

Setting Data Fields

Set the display content of the data fields displayed on each page.

- 1 Press the [Menu] button.**
- 2 Use the [←]/[→] buttons to select [Settings] and then press the [Confirm] button.**

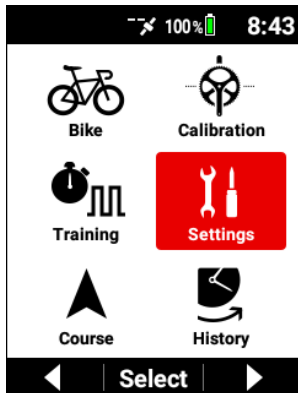

- 3** Use the [←]/[→] buttons to select [Data Fields] and then press the [Confirm] button.

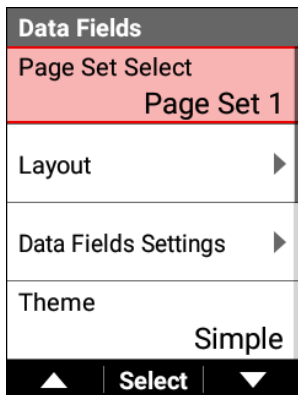
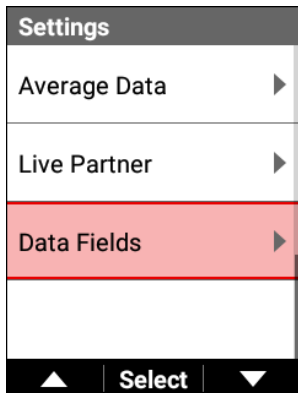

Setting item	Description
Page Set Select	Select the page set to which you wish to switch from the page set list.

Layout	Select the page for which you wish to change the layout from pages 1 to 10 and then select from 17 layout types. To hide the page, select [OFF]. The layout that is currently selected has a red borderline around it. When [OFF] is selected for that layout, a blue borderline is displayed around it.
Data Fields Settings	First select the page to set from page numbers 1 to 10 and then set any display content for each data field number depending on the corresponding layout. Set each of the data field type, data category, data type, and display type. If there is one setting value, the setting cannot be changed.
Theme	Switch the design of the data fields. When [Simple]* is selected, the data fields are displayed without a label background. When [Traditional] is selected, the data fields are displayed with a label background that is gray and with a sub-label that has red text.
Page Set Initialize	Initialize the page set to factory default settings.

*: Factory default setting

■ Layout Pattern List

You can set a "numerical value" type in white data fields, "numerical value" and "graph" types in the light gray data fields, and "numerical value," "graph," and "course" types in the dark gray data fields.

① Number of data fields: 3

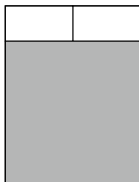

② Number of data fields: 4

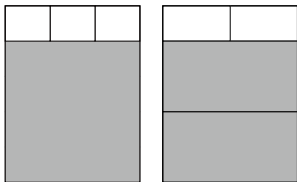

③ Number of data fields: 5

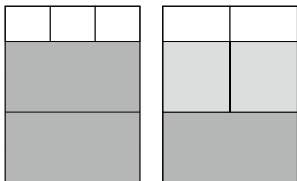

④ Number of data fields: 6

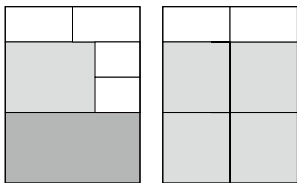

⑤ Number of data fields: 7

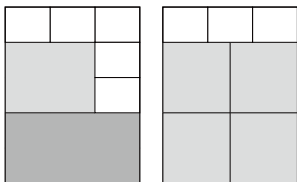

⑥ Number of data fields: 8

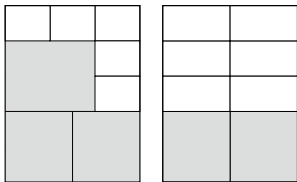

⑦ Number of data fields: 9

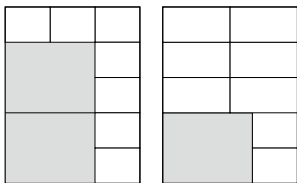

⑧ Number of data fields: 10

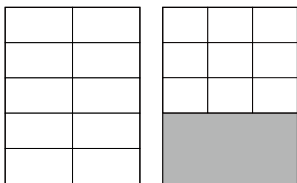

⑨ Number of data fields: 11

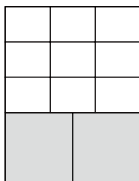

⑩ Number of data fields: 15

■ Data Field Setting Details

Numerical type

The following items can be set for a numerical type data field.

- Data category
Specifies the category of the display data.
- Data type
Specifies the data type, such as an average value or maximum value, etc.
- Display type
Specifies the time display format, average value calculation range, etc.

Data category	Data type	Display type	Label	Sub-label	Data type description
Date	Date	<ul style="list-style-type: none"> • yyyy/ MM/ dd • yyyy MMM dd • MM/ dd • MMM dd 	Date	—	Current date
Clock Time	Clock Time	<ul style="list-style-type: none"> • hh:mm:ss • hh:mm 	Clock	—	Current time
Timer	Time	<ul style="list-style-type: none"> • hh:mm:ss 	Time	—	Current ride time
	Time Lap	<ul style="list-style-type: none"> • hh:mm • Auto 		Lap	Ride time per lap
	Last Lap Time	hh:mm:ss		Lst	Last lap ride time
	Fastest Lap		BestLap	—	Fastest ride time out of the ride times for individual laps
	Elapsed Time	<ul style="list-style-type: none"> • hh:mm:ss • hh:mm • Auto 	Elapsed	—	Time elapsed from the log data start to now, including during auto pause or when logging is stopped.
	Total Time Bike	<ul style="list-style-type: none"> • d h • h m 	Time	Bike	Total ride time per bike
	Total Time			User	Total ride time of all bikes

Distance	Distance	km or mile (*1)	Dist	—	Current ride distance			
	Distance Lap			Lap	Ride distance per lap			
	Distance Last Lap			Lst	Last lap ride distance			
	Total Distance Bike		Dist	B	Total ride distance per bike			
	Total Distance			U	Total ride distance of all bikes			
Speed	Speed	km/ h or mph (*1)	Spd	—	Current speed			
	Speed Avg			Av	Current average speed			
	Speed Lap Avg			LapAv	Average speed per lap			
	Speed n sec Avg	km/ h or mph (*1)		Ns	Average speed for fixed period			
	Speed Max			Mx	Fastest speed			
	Speed Lap Max			LapMx	Fastest speed per lap			
	Speed Last Lap Avg			LstAv	Last lap average speed			
	Speed Last Lap Max			LstMx	Last lap fastest speed			
	Cadence			Cadence	rpm	Cad	—	Number of revolutions of the crank per minute
				Cadence Avg			Av	Average number of revolutions of the crank
Cadence Lap Avg		LapAv	Average number of revolutions of the crank per lap					
Cadence n sec Avg		rpm		Ns	Average number of revolutions of the crank for a fixed period			
Cadence Max				Mx	Maximum number of revolutions of the crank			
Cadence Lap Max				LapMx	Maximum number of revolutions of the crank per lap			
Cadence Last Lap Avg				LstAv	Average number of revolutions of the crank for last lap			
Cadence Last Lap Max				LstMx	Maximum number of revolutions of the crank for last lap			

Heart Rate	Heart Rate	· bpm · %HRR · %MAX · ZONE	HR	—	Current heart rate
	Heart Rate Avg			Av	Average heart rate
	Heart Rate Lap Avg			LapAv	Average heart rate per lap
	Heart Rate n sec Avg	· 3 s. Avg · 5 s. Avg · 10 s. Avg · 30 s. Avg · 60 s. Avg		Ns	Average heart rate for fixed period
	Heart Rate Max			· bpm · %HRR · %MAX · ZONE	Mx
	Heart Rate Lap Max				LapMx
	Heart Rate Last Lap Avg			LstAv	Last lap average heart rate
	Heart Rate Last Lap Max			LstMx	Last lap maximum heart rate
Calories	Calories	kcal	Cal	—	Current consumed calories
	Calories Lap			Lap	Consumed calories per lap
Training Timer	Number of Intervals	-	Count	—	Number of Intervals
	Remaining Time		Remain	—	Remaining time
	Target	Watt	Target	—	Target power of training
	Next Target		NextTgt	—	Next target power of training

Power Training (*2)	TSS™	-	TSS	—	Representation of the load on the body as a numerical value based on the intensity and time of training.
	IF™		IF	—	Intensity factor. Representation of the training intensity as a factor based on the NP™ and FTP.
	NP™	Watt	NP	—	Normalized power. Value normalized in consideration of load fluctuations during training.
	Lap NP™			Lap	NP™ per lap
	Last Lap NP™			Lst	Last lap NP™
	Intensity	<ul style="list-style-type: none"> • Auto • 3 min • 5 min • 10 min • 20 min 	Int	Ns, Nmin	Exercise intensity for fixed period. Ratio of MMP to average power for fixed period. "Auto" displays the period when the ratio is the highest.
<ul style="list-style-type: none"> • IF™ and TSS™ are not displayed correctly if [FTP] is not entered correctly on the SGX-CA600. • The FTP value needs to be set for each of the SGX-CA600 and Cyclo-Sphere. • Set the FTP value in [Settings] > [User Settings] > [FTP]. • Intensity is an index to display the training intensity in real time. 					
<p>When performing training for a short time with a high power value or performing training for a long time with a low power value, you can do so easily by setting the numerical value of this function as the goal to be attained.</p> <p>Use 70 to 90% as a guide for the target of training intensity and duration.</p> <p>The average power is calculated in real time with respect to each time of the MMP parameters set in [User Settings] to display the ratios to the MMPs. When "Auto" is selected, the highest ratio is displayed together with the time.</p> <p>The duration at the bottom left of the data field is automatically updated to the time that the intensity is the highest.</p> <p>The value becomes higher in accordance with the duration, and becomes 100% when the MMP is updated.</p> <ul style="list-style-type: none"> • To use this function, you need a Pioneer pedaling monitor sensor or ANT+ power meter. Set each time of [Settings] > [User Settings] > [MMP]. • You can download the MMP parameters for three months in the past from the accumulated log data by synchronizing with Cyclo-Sphere in [Settings] > [Cyclo-Sphere]. • The intensity of 60 minutes indicates the ratio to the FTP value. Therefore, even if you do not have the best data for 60 minutes for the last three months, the training intensity can be displayed properly. Set this from [Settings] > [User Settings] > [FTP]. 					

Power (*2)	Power	<ul style="list-style-type: none"> · Watt · %FTP · %CP · LEVEL · W/kg 	Pwr	—	Current output. This indicates the power value of the ANT+power meter or ANT+smart trainer. If an ANT+power meter or smart trainer is not connected when a pedaling monitor sensor is connected, this indicates the power value of the pedaling monitor sensor.	
	Power Avg			Av	Average Output	
	Power Lap Avg			LapAv	Output per lap	
	Power n sec Avg	<ul style="list-style-type: none"> · 3 s. Avg · 5 s. Avg · 10 s. Avg · 30 s. Avg · 60 s. Avg 		Ns	Average output for fixed period	
	Power Max	<ul style="list-style-type: none"> · Watt · %FTP · %CP · LEVEL · W/kg 		Mx	Maximum output	
	Power Lap Max			LapMx	Maximum output per lap	
	Power Last Lap Avg			LstAv	Last lap average output	
	Power Last Lap Max			LstMx	Last lap maximum output	
	Total Work Amount	kJ		Work	—	Total work amount
	Total Work Amount Lap				Lap	Total work amount per lap
Power Balance	Power Balance	%	Bal/ BalLR	—	Left/ right ratio of current power. This indicates the left/ right ratio of the ANT+ power meter or smart trainer. If an ANT+ power meter or smart trainer is not connected or balance display is not supported when a pedaling monitor sensor is connected, this indicates the left/ right ratio of the pedaling monitor sensor.	
	Power Bal Avg			Av	Average left/ right ratio	
	Power Bal Step Avg			LapAv	Average left/ right ratio per lap	
	Power Bal n sec Avg	<ul style="list-style-type: none"> · 3 s. Avg · 5 s. Avg · 10 s. Avg · 30 s. Avg · 60 s. Avg 		Ns	Average left/ right ratio for fixed period	

Torque L	Torque L	N·m	TrqL	—	Current torque for left side. This indicates the current torque for the left side of the ANT+ power meter or smart trainer. If an ANT+ power meter or smart trainer is not connected or torque display is not supported when a pedaling monitor sensor is connected, this indicates the torque for the left side of the pedaling monitor sensor.
	Torque L Avg			Av	Average torque for left side
	Torque L Lap Avg			LapAv	Average torque per lap for left side
	Torque L n sec Avg	N·m		Ns	Average torque of fixed period for left side
	Torque L Max			Mx	Maximum torque for left side
	Torque L Lap Max			LapMx	Maximum torque per lap for left side
	Torque L Last Lap Avg			LstAv	Average torque for last lap for left side
	Torque L Last Lap Max			LstMx	Maximum torque for last lap for left side
Torque R	Torque R	N·m	TrqR	—	Current torque for right side. This indicates the current torque for the right side of the ANT+ power meter or smart trainer. If an ANT+ power meter or smart trainer is not connected or torque display is not supported when a pedaling monitor sensor is connected, this indicates the torque for the right side of the pedaling monitor sensor.
	Torque R Avg			Av	Average torque for right side
	Torque R Lap Avg			LapAv	Average torque per lap for right side

	Torque R n sec Avg	<ul style="list-style-type: none"> • 3 s. Avg • 5 s. Avg • 10 s. Avg • 30 s. Avg • 60 s. Avg 		Ns	Average torque of fixed period for right side
	Torque R Max	N·m		Mx	Maximum torque for right side
	Torque R Lap Max		LapMx	Maximum torque per lap for right side	
	Torque R Last Lap Avg		LstAv	Average torque for last lap for right side	
	Torque R Last Lap Max		LstMx	Maximum torque for last lap for right side	
Torque LR	Torque LR	N·m	Trq	—	Current torque for left and right sides. This indicates the current torque for the left and right sides of the ANT+ power meter or smart trainer. If an ANT+ power meter or smart trainer is not connected or torque display is not supported when a pedaling monitor sensor is connected, this indicates the torque for the left and right sides of the pedaling monitor sensor.
	Torque LR Avg			Av	Average torque for left and right sides
	Torque LR Lap Avg			LapAv	Average torque per lap for left and right sides
	Torque LR n sec Avg	<ul style="list-style-type: none"> • 3 s. Avg • 5 s. Avg • 10 s. Avg • 30 s. Avg • 60 s. Avg 		Ns	Average torque of fixed period for left and right sides
	Torque LR Max	N·m		Mx	Maximum torque for left and right sides
	Torque LR Lap Max			LapMx	Maximum torque per lap for left and right sides
	Torque LR Last Lap Avg			LstAv	Average torque for last lap for left and right sides
	Torque LR Last Lap Max			LstMx	Maximum torque for last lap for left and right sides
Torque Effect	Torque Effect	%	TE	—	Ratio of positive torque with respect to the total for the positive and negative torque in the rotation direction (tangential direction)

	Pedal Smoothness		PS	—	Maximum torque with respect to the average torque in the rotation direction (tangential direction)
	GPR	Watt	GPR	—	Abbreviation for Gross Power Released, which is the positive power value calculated from the rotation direction (tangential direction) positive torque and cadence.
	GPA		GPA	—	Abbreviation for Gross Power Absorbed, which is the negative power value calculated from the rotation direction (tangential direction) negative torque and cadence. Value resulting from subtracting the GPR from the current power value.
	KI	-	KI	—	Abbreviation for Kurtotic Index, which is the inverse of the pedal smoothness. Index to represent pedaling smoothness.
	Torque Effect L	%	TE L	—	Ratio of positive torque with respect to the total torque for the left side
	Pedal Smoothness L		PS L	—	Ratio of maximum torque with respect to the average torque for the left side
	GPR L	Watt	GPR L	—	Positive power value for the left side
	GPA L		GPA L	—	Negative power value for the left side
	KI L	-	KI L	—	Inverse of the pedal smoothness for the left side
	Torque Effect R	%	TE R	—	Ratio of positive torque with respect to the total torque for the right side
	Pedal Smoothness R		PS R	—	Ratio of maximum torque with respect to the average torque for the right side
	GPR R	Watt	GPR R	—	Positive power value for the right side
	GPA R		GPA R	—	Negative power value for the right side
	KI R	-	KI R	—	Inverse of the pedal smoothness for the right side
Pedaling L	Power L	Watt	PmL	—	Output of the pedaling monitor on the left side
	Power L Avg			Av	Average output of the pedaling monitor on the left side
	Power L Lap Avg			LapAv	Average output per lap for the pedaling monitor on the left side
	Power L n sec Avg			Ns	Average output for fixed period for the pedaling monitor on the left side
		· 3 s. Avg · 5 s. Avg · 10 s. Avg · 30 s. Avg · 60 s. Avg			

	Power L Max	Watt		Mx	Maximum output of the pedaling monitor on the left side
	Power L Lap Max			LapMx	Maximum output per lap for the pedaling monitor on the left side
	Power L Last Lap Avg			LstAv	Last lap average output for the pedaling monitor on the left side
	Power L Last Lap Max			LstMx	Last lap maximum output for the pedaling monitor on the left side
Pedaling Efficiency L	Pedaling Efficiency L	%	EffL	—	Ratio of the total sum of the force in the rotation direction with respect to the total sum of the resultant force of the force in the rotation direction (tangential direction) and the force in the vertical direction (normal direction) in the rotation direction for one revolution of the crank for the pedaling monitor on the left side. Force in the rotation direction is calculated as plus in the rotation direction and minus in the reverse direction.
	Efficiency L Avg			Av	Average pedaling efficiency for the pedaling monitor on the left side
	Efficiency L Lap Avg			LapAv	Average pedaling efficiency per lap for the pedaling monitor on the left side
	Pedaling Efficiency L n sec Avg	<ul style="list-style-type: none"> • 3 s. Avg • 5 s. Avg • 10 s. Avg • 30 s. Avg • 60 s. Avg 		Ns	Average pedaling efficiency for fixed period for the pedaling monitor on the left side
Pedaling Loss L	Pedaling Loss L	%	LossL	—	Ratio of the total sum of the force in the rotation direction and vertical direction with respect to the total sum of the resultant force of the force in the rotation direction (tangential direction) and the force in the vertical direction (normal direction) in the rotation direction for one revolution of the crank for the pedaling monitor on the left side.
	Loss L Avg			Av	Average loss rate for the pedaling monitor on the left side
	Loss L Lap Avg			LapAv	Average loss rate per lap for the pedaling monitor on the left side
	Loss L n sec Avg	<ul style="list-style-type: none"> • 3 s. Avg • 5 s. Avg • 10 s. Avg • 30 s. Avg • 60 s. Avg 		Ns	Average loss rate for fixed period for the pedaling monitor on the left side

Pedaling R	Power R	Watt	PmR	—	Output of the pedaling monitor on the right side
	Power R Avg			Av	Average output of the pedaling monitor on the right side
	Power R Lap Avg			LapAv	Average output per lap for the pedaling monitor on the right side
	Power R n sec Avg	· 3 s. Avg · 5 s. Avg · 10 s. Avg · 30 s. Avg · 60 s. Avg		Ns	Average output for fixed period for the pedaling monitor on the right side
	Power R Max	Watt		Mx	Maximum output of the pedaling monitor on the right side
	Power R Lap Max			LapMx	Maximum output per lap for the pedaling monitor on the right side
	Power R Last Lap Avg			LstAv	Last lap average output for the pedaling monitor on the right side
	Power R Last Lap Max			LstMx	Last lap maximum output for the pedaling monitor on the right side
Pedaling Efficiency R	Pedaling Efficiency R	%	EffR	—	Ratio of the total sum of the force in the rotation direction with respect to the total sum of the resultant force of the force in the rotation direction (tangential direction) and the force in the vertical direction (normal direction) in the rotation direction for one revolution of the crank for the pedaling monitor on the right side. Force in the rotation direction is calculated as plus in the rotation direction and minus in the reverse direction.
	Efficiency R Avg			Av	Average pedaling efficiency for the pedaling monitor on the right side
	Efficiency R Lap Avg			LapAv	Average pedaling efficiency per lap for the pedaling monitor on the right side
	Pedaling Efficiency R n sec Avg	· 3 s. Avg · 5 s. Avg · 10 s. Avg · 30 s. Avg · 60 s. Avg		Ns	Average pedaling efficiency for fixed period for the pedaling monitor on the right side

	Pedaling Loss R	%	LossR	—	Ratio of the total sum of the force in the rotation direction and vertical direction with respect to the total sum of the resultant force of the force in the rotation direction (tangential direction) and the force in the vertical direction (normal direction) in the rotation direction for one revolution of the crank for the pedaling monitor on the right side.	
	Loss R Avg			Av	Average loss rate for the pedaling monitor on the right side	
	Loss R Lap Avg			LapAv	Average loss rate per lap for the pedaling monitor on the right side	
	Loss R n sec Avg	<ul style="list-style-type: none"> · 3 s. Avg · 5 s. Avg · 10 s. Avg · 30 s. Avg · 60 s. Avg 		Ns	Average loss rate for fixed period for the pedaling monitor on the right side	
Pedaling LR	Power LR	<ul style="list-style-type: none"> · Watt · %FTP 	Pm	—	Output of the pedaling monitors on the left and right sides	
	Power LR Avg	<ul style="list-style-type: none"> · %CP · LEVEL 		Av	Average output of the pedaling monitors on the left and right sides	
	Power LR Lap Avg	<ul style="list-style-type: none"> · W/kg 		LapAv	Average output per lap for the pedaling monitors on the left and right sides	
	Power LR n sec Avg	<ul style="list-style-type: none"> · 3 s. Avg · 5 s. Avg · 10 s. Avg · 30 s. Avg · 60 s. Avg 		Ns	Average output for fixed period for the pedaling monitors on the left and right sides	
	Power LR Max	<ul style="list-style-type: none"> · Watt · %FTP 		Mx	Maximum output of the pedaling monitors on the left and right sides	
	Power LR Lap Max	<ul style="list-style-type: none"> · %CP · LEVEL 		LapMx	Maximum output per lap for the pedaling monitors on the left and right sides	
	Power LR Last Lap Avg	<ul style="list-style-type: none"> · W/kg 		LstAv	Last lap average output for the pedaling monitors on the left and right sides	
	Power LR Last Lap Max			LstMx	Last lap maximum output for the pedaling monitors on the left and right sides	
	Power Max n sec Avg	<ul style="list-style-type: none"> · 3 s. Avg · 5 s. Avg · 10 s. Avg 		Pm	NsMx	Maximum output for fixed period for the pedaling monitors on the left and right sides
	Power LR Lap Max n sec Avg	<ul style="list-style-type: none"> · 30 s. Avg · 60 s. Avg 			NsLMx	Maximum output for fixed period per lap for the pedaling monitors on the left and right sides

	Power LR Last Lap Max n sec Avg			NsLLMx	Maximum output for fixed period of the last lap for the pedaling monitors on the left and right sides
	Total Work Amount LR	kJ	PmWork	—	Total work amount of the pedaling monitors on the left and right sides
	Total Work Amount LR Lap			Lap	Total work amount per lap for the pedaling monitors on the left and right sides
Pedaling Balance LR	Power Balance	%	PmBal	—	Left/ right ratio of the pedaling monitors on the left and right sides
	Power Bal Avg			Av	Average left/ right ratio of the pedaling monitors on the left and right sides
	Power Bal Step Avg			LapAv	Average left/ right ratio per lap for the pedaling monitors on the left and right sides
	Power Bal n sec Avg	Ns		<ul style="list-style-type: none"> • 3 s. Avg • 5 s. Avg • 10 s. Avg • 30 s. Avg • 60 s. Avg 	Average left/ right ratio for fixed period for the pedaling monitors on the left and right sides
	Power Bal Last Lap Avg				LstAv
Pedaling Efficiency LR	Pedaling Efficiency LR	%	Eff	—	Ratio of the total sum of the force in the rotation direction with respect to the total sum of the resultant force of the force in the rotation direction (tangential direction) and the force in the vertical direction (normal direction) in the rotation direction for one revolution of the crank for pedaling monitors on the left and right sides. Force in the rotation direction is calculated as plus in the rotation direction and minus in the reverse direction.
	Efficiency LR Avg			Av	Average pedaling efficiency for the pedaling monitors on the left and right sides
	Efficiency LR Lap Avg			LapAv	Average pedaling efficiency per lap for the pedaling monitors on the left and right sides
	Pedaling Efficiency LR n sec Avg	Ns		<ul style="list-style-type: none"> • 3 s. Avg • 5 s. Avg • 10 s. Avg • 30 s. Avg • 60 s. Avg 	Average pedaling efficiency for fixed period for the pedaling monitors on the left and right sides

	Efficiency LR Last Lap Avg	%		LstAv	Last lap average pedaling efficiency for the pedaling monitors on the left and right sides	
	Pedaling Efficiency LR			—	Displays the left and right pedaling efficiency for the pedaling monitors on the left and right sides separately	
	Pedaling Efficiency LR Avg	<ul style="list-style-type: none"> • 3 s. Avg • 5 s. Avg • 10 s. Avg • 30 s. Avg • 60 s. Avg 		Av	Displays the left and right average pedaling efficiency for the pedaling monitors on the left and right sides separately	
	Pedaling Efficiency LR Lap Avg			LapAv	Displays the left and right average pedaling efficiency per lap for the pedaling monitors on the left and right sides separately	
	Pedaling Efficiency LR n sec Avg			Ns	Displays the left and right average pedaling efficiency for fixed period for the pedaling monitors on the left and right sides separately	
	Pedaling Efficiency LR Last Lap Avg		%		LstAv	Displays the left and right average pedaling efficiency for the last lap for the pedaling monitors on the left and right sides separately
	Pedaling Loss LR	Loss			—	Ratio of the total sum of the force in the rotation direction and vertical direction with respect to the total sum of the resultant force of the force in the rotation direction (tangential direction) and the force in the vertical direction (normal direction) in the rotation direction for one revolution of the crank for the pedaling monitor on the left and right sides.
	Loss LR Avg				Av	Average loss rate for the pedaling monitors on the left and right sides
	Loss LR Lap Avg				LapAv	Average loss rate per lap for the pedaling monitors on the left and right sides
	Loss LR n sec Avg			<ul style="list-style-type: none"> • 3 s. Avg • 5 s. Avg • 10 s. Avg • 30 s. Avg • 60 s. Avg 		Ns
Temperature	Temperature	°C	Temp	—	Current temperature	
	Temperature Avg			Av	Average temperature	
	Temperature Max			Mx	Temperature Max	

	Temperature Min			Min	Minimum air temperature
Air Pressure	Air Pressure	hPa	Atm	—	Current air pressure
Altitude	Altitude	m or ft (*1)	Alt	—	Current altitude
	Elevation Gain		EleG	—	Total value for difference in elevation ascended
	Elevation Gain Lap		Lap	—	Total value for difference in elevation ascended per lap
	Elevation Loss		EleL	—	Total value for difference in elevation descended
	Elevation Loss Lap		Lap	—	Total value for difference in elevation descended per lap
	Elevation Gain Last Lap		EleG	Lst	—
Gradient	Gradient	%	Grade	—	Gradient
Lap Count	Lap Count	Count	Lap	—	Lap count
GPS	Latitude	Lat	Lat	—	Latitude of current position
	Longitude	Lon	Lon	—	Longitude of current position
Gear	Front/ Rear	· Gear Position · Teeth	Gear	FR	Displays gear position and number of teeth for the front and rear
	Front	· Gear Position · Position/Max · Teeth		F	Displays gear position and number of teeth for the front
	Rear	· Gear Position · Position/Max · Teeth		R	Displays gear position and number of teeth for the rear
	Gear Ratio	Ratio		Ratio	Displays gear ratio for the front and rear
Battery	Main Unit	%	Batt	HU	Remaining battery power of device
	Left Pedaling Monitor	· Level · Volt		PmL	Remaining battery power of left pedaling monitor
	Right Pedaling Monitor	· Level · Volt		PmR	Remaining battery power of right pedaling monitor
	Power Meter	Level		Pwr	Remaining battery power of power meter
	Di2	%		Di2	Remaining battery power of Di2
	Front Derailleur	Level		FD	Remaining battery power of front derailleur
	Rear Derailleur			RD	Remaining battery power of rear derailleur
	Left Shifter			ShiftL	Remaining battery power of left shifter

	Right Shifter			ShiftR	Remaining battery power of right shifter
	System Derailleur			DL	Remaining battery power of system derailleur
	Bicycle Light			L# Type	Bicycle light battery level #: Light number Type: light type (head: headlight, tail: tail light)
Road Surface information	Vibration	G	Road	—	Current vibration amount
	Vibration Avg			Av	Average vibration amount
	Vibration Lap Avg			LapAv	Average vibration amount per lap
	Vibration n sec Avg			Ns	Average vibration amount for fixed period
	Vibration Max	G		Mx	Maximum vibration amount
	Vibration Lap Max			LapMx	Maximum vibration amount per lap
	Vibration Last Lap Avg			LstAv	Last lap average vibration amount
	Vibration Last Lap Max			LstMx	Last lap maximum vibration amount
Live Partner	User Name	Partner 1	Pt#	—	User name of live partner
	3-second Average Power	Partner 2		3s	3-second average output of live partner
	3-second Average Power Body-Weight Ratio	Partner 3		3s	3-second-average output of live partner (body-weight ratio)
	Power Avg			Av	Average output of live partner
	Power Lap Avg			LapAv	Average output per lap of live partner
	Pedaling Efficiency LR			Eff	Left and right pedaling efficiency of live partner
	TSS™			TSS	TSS™ of live partner
	Intensity			IntNs	Intensity of live partner
	Cadence			Cad	Cadence of live partner
	Heart Rate			HR	Heart rate of live partner
	Calories			Cal	Consumed calories of live partner
	%MAX Heart Rate			HR	Ratio to the maximum heart rate of the heart rates of the live partner

Course	Distance to Destination	km or mile (*1)	Course	DistD	Distance to destination
	Direction to Destination	-		DirecD	Direction to destination
	Turning point distance	km or mile (*1)	DistT	—	Distance to next left or right turn point
	Turning point message	—	NextTTxt	—	Text information display for next left or right turn point
	Cue point distance	km or mile (*1)	DistC	—	Distance to next cue point
	Cue point message	—	NextCTxt	—	Text information display for next cue point
	Arrival Time Destination	hh:mm:ss/ hh:mm	ClockD	—	Predicted time of arrival at destination
	Remaining Time Destination	Auto	TimeD	—	Predicted remaining time to destination
Strava Live Segment	Distance to Start Point	km or mile (*1)	DistS	—	Distance to the start point of the segment
	Elevation Gain	m or ft	SegEleG	—	Elevation gain of the segment
	KOM	Auto	KOM	—	KOM time for the segment
	Personal Record		PR	—	Personal record for the segment
	Remaining Distance	km or mile (*1)	SegRem	—	Remaining distance of the segment
	Time Ahead/behind KOM	Auto	KOM Diff	—	When you select [Settings]> [User Settings]> [Gender]> [Female], QOM is displayed.
	Time Ahead/behind PR		PR Diff	—	Time ahead/ behind personal record ratio for the segment
	Elapsed Time		SegElap	—	Time elapsed from the start of the segment until now
Wind Information	Wind Speed	m/s, mph or km/h	WindSpd	—	Activating wind information acquisition in the Cyclo-Sphere Control App will activate wind speed and wind direction for the the current GPS location of the cyclocomputer to be acquired from the server via the Control App once per hour. If wind speed and direction can not be acquired, information entered in Virtual Settings is displayed and an "F" is displayed in the top right corner of the data field. "CALM" is displayed if there is no wind. Wind direction is displayed as "N" for a north wind and "S" for a south wind.
	Wind Direction	—	WindDir	—	
	Bike Wind Direction	—	BikeWind	—	Direction of wind in relation to the direction of bike travel
	Airspeed	km/h or mph (*1)	AirSpd	—	The relative velocity of the air and the bike, taking account of wind direction and wind speed

CdA	CdA	—	CdA	—	CdA is an index related to the aerodynamics of the bike that combines the drag coefficient Cd, with the frontal projected area, A. This value becomes lower when you ride in a stance that has low air resistance or on a bicycle with a streamlined body. If the ANT+ power meter or a pedaling monitor sensor is connected, virtual CdA is estimated using the information acquired using the device, user information entered, and virtual setting information. In the virtual CdA display, "V" is displayed in the top right of each data field. If these devices are not connected the CdA value entered in virtual settings is displayed, and "F" is displayed in the top right of each data field.
	Average CdA	—		Av	
	CdA Lap Avg	—		LapAv	
	CdA n sec Avg	<ul style="list-style-type: none"> • 3s. Avg • 5s. Avg • 10s. Avg • 30s. Avg • 60s. Avg 		Ns	
	CdA Best	—		Bst	
	CdA Lap Best	—		LapBst	
	CdA Last Lap	—		LstAv	
	CdA Last Lap Best	—		LstBst	

*1 Please modify so that user can choose w/kg as units, even if they use miles/ft/lbs for other displays.

For details on the unit system, refer to "[System Settings](#)."

*2 The virtual power value is estimated based on user information entered and virtual setting information. In the virtual power display, "V" is displayed in the top right corner of each data field.

Graph type

Pedaling graph

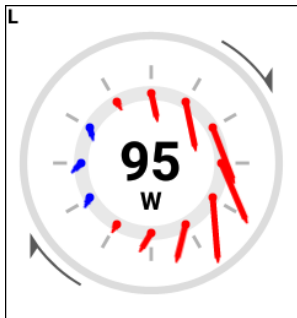

Drawing mode	Drawing side	Data type	Display type
<ul style="list-style-type: none"> • Vector display • Torque display 	<ul style="list-style-type: none"> • Left • Right • Left and right 	Power	Watt
		Power n sec Avg	<ul style="list-style-type: none"> • 3 s. Avg • 5 s. Avg • 10 s. Avg
		Pedaling Efficiency	%
		Pedaling Efficiency n sec Avg	<ul style="list-style-type: none"> • 3 s. Avg • 5 s. Avg • 10 s. Avg

Gear graph

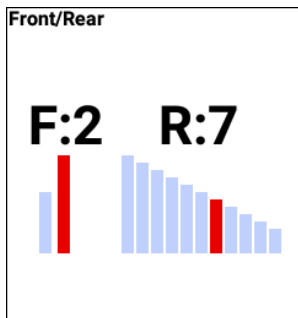

Gear Position

- Front
- Rear
- Front/rear

Training

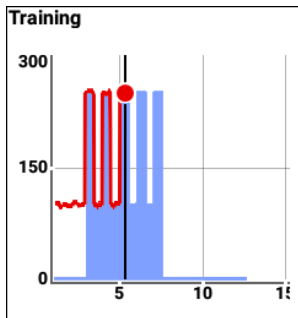

Training Timer

- 5 min
 - 10 min
 - 20 min
 - 60 min
-

TSS™

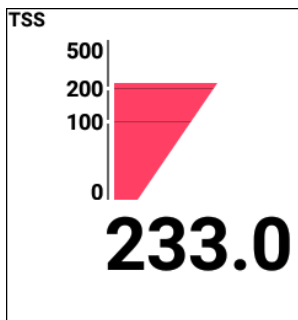

MMP

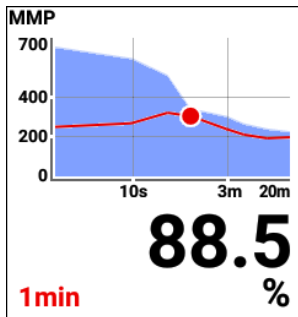

Intensity

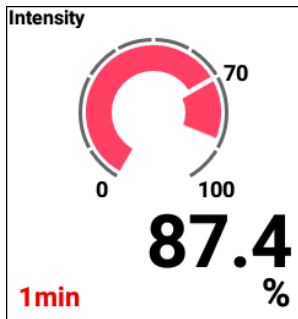

Level

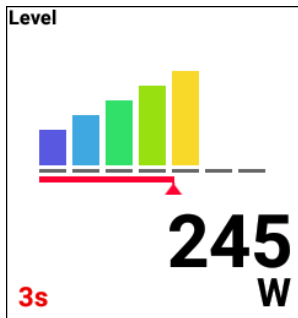

Balance

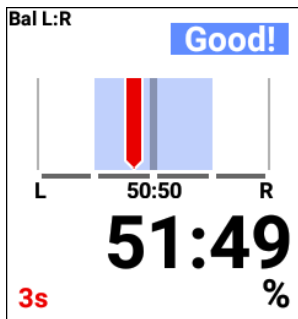

Pedaling efficiency

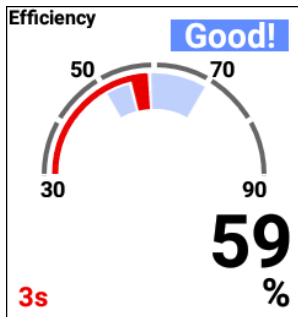

Course

Up to one course can be placed on one page.



Course	History
<ul style="list-style-type: none">• Enable• Disable	<ul style="list-style-type: none">• Enable• Disable

Profile

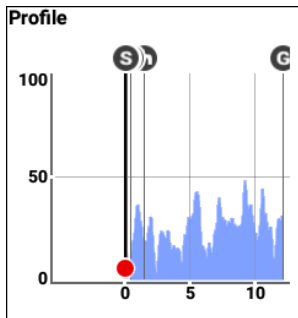

Distance

- 1.0 km
- 5 km
- 10 km
- 50 km
- 100 km
- 200 km
- 500 km

or

- 0.6 mi
 - 3 mi
 - 6 mi
 - 30 mi
 - 60 mi
 - 120 mi
 - 300 mi
-

Live Partner

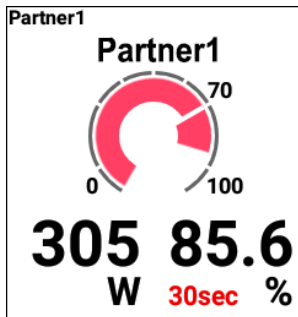

Live Partner

- Partner 1
- Partner 2
- Partner 3

Cue sheet

Cue Sheet	
0 ft Start	S
Start of route	
230 ft Palos Verd	↶
Turn left to stay on Palos Verdes Dr W	
242 ft Sharp Vía	↷
Sharp right toward Vía Chico	

Cue Sheet

- All
- Turn by Turn
- Cue Point

Strava Live segment

A course can be placed in the largest data field of the course type.

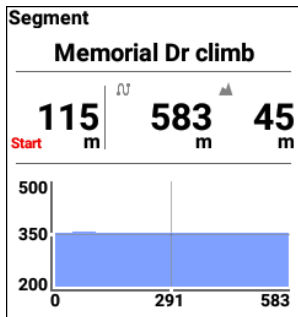

Target

- KOM
 - PR
-

Segment profile

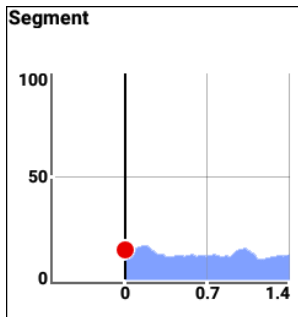

LapList

LapList		
Lap	Time	Pwr W
10	00:00:30	138.2
9	00:00:30	253.6
8	00:00:30	129.1
7	00:00:30	255.1
6	00:00:30	135.0
5	00:00:30	259.5
4	00:00:30	140.7

Display Item	Hide Rest Lap
<ul style="list-style-type: none"> • Power Lap Avg • NP Lap Avg • Heart Rate Lap Avg • Speed Lap Avg 	<ul style="list-style-type: none"> • Enable • Disable

CdA

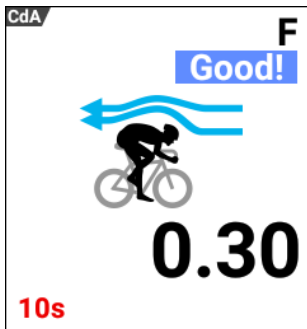

Note

- If an ANT+ Power Meter or Pedaling Monitor is not connected, an estimated Virtual Power value is displayed based upon user and Virtual setting information. In Training, TSS, MMP, Intensity, and Level are also estimated. In the Virtual Power display, a "V" is displayed in the top right corner of each data field.
- For CdA, Virtual CdA is calculated when an ANT+ Power Meter or Pedaling Monitor is connected, a "V" will be displayed in the top right corner of each data field. When these devices are not connected, Virtual CdA is not calculated. An "F" is displayed in the top right corner of each data field, and the fixed CdA value set in the virtual settings is displayed. Virtual CdA values are not recorded in log data.

User Settings

Register and set the user information.

Set the user information correctly to ensure accurate data can be acquired.

- 1 Press the [Menu] button.**
- 2 Use the [←]/[→] buttons to select [Settings] and then press the [Confirm] button.**

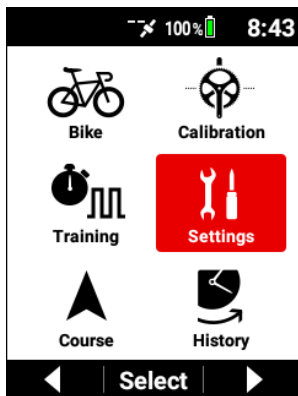

- 3** Use the [←]/[→] buttons to select [User Settings] and then press the [Confirm] button.

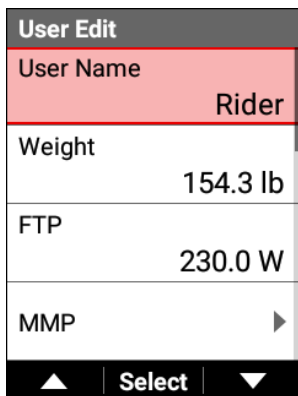
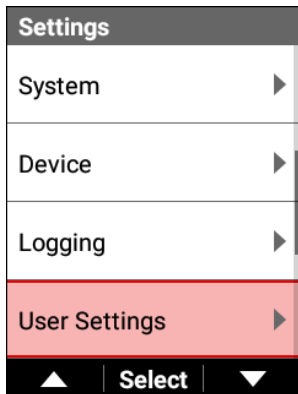

Setting item	Description
User Name	Enter the user name.
Weight	Enter your weight.

FTP	Enter your FTP value.
MMP	Enter MMP data for each of 10 seconds, 30 seconds, 1 minute, 3 minutes, 5 minutes, 10 minutes, and 20 minutes.
Power Level	Check your power level (L1 to L7) based on the FTP value.
Heart Rate Max	Enter your maximum heart rate.
Heart Rate Min	Enter your resting heart rate.
Heart Rate Zone	Check your heart rate zone (Z1 to Z5) based on your maximum heart rate and your resting heart rate.
VO2MAX	Enter your maximum oxygen intake. Use this value and your heart rate to calculate the calories.
Gender	Set any of [Male], [Female], and [N/A].
Birthday	Set your date of birth. The order of the year, month, and day is dependent on the [Date & Time] - [Date Format] settings in the system settings.

Average value setting

For the power, cadence, and average value calculation of speed, settings can be made to exclude data with zero values.

Settings can be made such that Average Power and Average Cadence do not decrease when crank rotation is stopped, such as when riding down a slope.

1 Press the [Menu] button.

- 2** Use the [←]/[→] buttons to select [Settings] and then press the [Confirm] button.

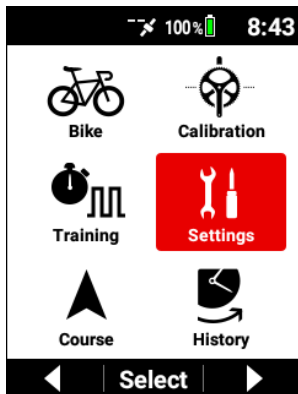

- 3** Use the [←]/[→] buttons to select [Average Data] and then press the [Confirm] button.

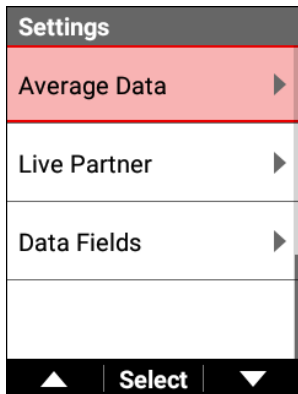

4 Set each item.

Average Data
Average Power With Zero Value
Average Cadence Without Zero Value
Average Speed With Zero Value
▲ Select ▼

The factory default setting is as follows.

Average Power : With Zero Value

Average Cadence : Without Zero Value

Average Speed : With Zero Value

Note

- This setting is not linked with the display settings of Cyclo-Sphere. For how to view and how to use the screen, see the following help page of Cyclo-Sphere.
<https://cyclo-sphere.com/help>

System Settings

Configure settings related to the general system of the device.

1 Press the [Menu] button.

- 2 Use the [←]/[→] buttons to select [Settings] and then press the [Confirm] button.

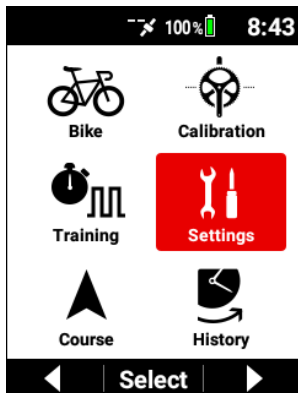

- 3 Use the [←]/[→] buttons to select [System] and then press the [Confirm] button.

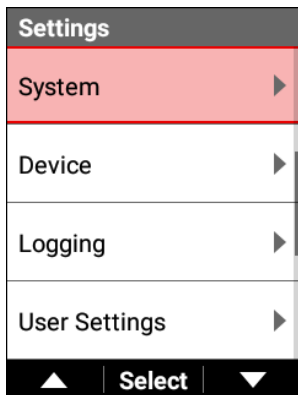

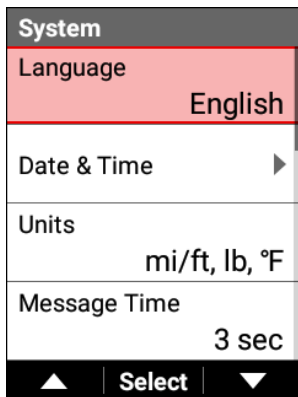

Setting item	Description
Language	Set the display language for the device (English*/日本語/Francais/Espariol/繁體中文/Nederlands/Deutsch/Italiano).
Date & Time	Set the time zone and the current date and time. If you select the [24-Hour Format] check box, the time is displayed in 24-hour format. You can also set the display order for the date.
Units	Set the display units (mi/ft,lb,°F*/km,kg,°C) for distance, elevation, air temperature, and weight.
Message Time	Set the time (1 second, 3 seconds*, or 5 seconds) to display the various messages that are displayed on the display.
Initialize / Back Up	Initialize and back up the device. You can also restore the status of the device using the backed up system data. ▶Performing Initialization ▶Making a Backup ▶Performing Restoration
Firmware Update	Update the firmware of the device.
Firmware Version	Check the system version of the device.
Serial Number	Check the serial number of the device.
Wi-Fi MAC address	Check the Wi-Fi MAC address of the device.
License	Display the open source license for the software installed on the device, and the trademark information and authentication information of the device.
Service Code	Enter the service code of the device.
Capture	Enable or disable* capture. If this is enabled, pressing and holding the [Lap] button captures the screen and saves the data to a PNG file in the device internal memory (/CA600/Pioneer/Capture/). The file name will be "CAPTURE_YYYY_MM_DD_hh_mm_ss.png." When saving completes, the "Screen capture saved." message appears. If saving failed because there is insufficient space, the "Screen capture failed." message appears.

*: Factory default setting

Note

- When the capture function is enabled, the function to save the logging data by pressing and holding the [Lap] button while logging is stopped will not work.

■ Performing Initialization

You can return the device system and application settings to the default states by selecting [Initialize / Back Up] → [Initialize] in the system settings described in the previous section.

When initialization completes, a message appears and the device restarts the system automatically.

After the restart, the initial setup screen appears. Perform the initial setup.

[Initial Setup](#)

Note

- If the device is connected to a PC with a USB cable, disconnect it before performing the initialization.
- While the device is connected with a PC, the contents of the memory may not be able to be displayed or updated.
Updating will occur if you disconnect and then reconnect the USB cable.
- If this device is performing logging, stop logging and save the log data.
- When initialization is performed, the system data is lost.
Save the backup data to the storage media of a PC or other device before the initialization.

[■ Making a Backup](#)

Initialized data

The settings target for initialization are the system settings, except for the [Date & Time], and the settings and log data of the meter screen.

All map data will be deleted and will not return to the default state. Please download the latest map again.

[Map Download](#)

■ Making a Backup

You can create backup data of the device system and application settings by selecting [Initialize / Back Up] → [Back Up] in the system settings described in the previous section.

If, for example, you accidentally initialize the system, you can restore the system by using a the backup data.

Note

- If the device is connected to a PC with a USB cable, disconnect it before making a backup.
- While the device is connected with a PC, the date of the backup file may not be updated.
Updating will occur if you disconnect and then reconnect the USB cable.
- If this device is performing logging, stop logging and save the log data.

Backed up data

The settings target for backup are the system settings, except for the [Date & Time], and the settings of the meter screen.

The log data is not included in the backup data.

Save the log data to the storage media of a separate PC or other device.

■ Performing Restoration

You can perform a restoration of backup data (/CA600/Pioneer/Setting/Backup.zip) by selecting [Initialize / Back Up] → [Restore] in the system settings described in the previous section.

When restoration completes, a message appears and the device restarts automatically.

Note

- If this device is performing logging, stop logging and save the log data before performing the restoration.

Restored data

The settings target for restoration are the system settings, except for the [Date & Time], and the settings of the meter screen.

■ Updating the Firmware

You can update the firmware of the device by selecting [Firmware Update] → [Update] in the system settings described in the previous section.

The latest firmware is obtained from the server and downloaded to the device via Wi-Fi.

Note

- Update the firmware when the device is fully charged.
- If the downloaded firmware data is damaged or a network error occurs, a message appears.

- If the firmware update fails, a message appears on the screen. Press and hold the [Power] button for 2 seconds or more to turn off the power.

When updating via Wi-Fi

The Wi-Fi function of the device needs to be enabled in advance.

Even if you have already set Wi-Fi, press the [Confirm] button to go to the Wi-Fi setting screen if a connection via Wi-Fi is not possible.

[Wi-Fi Settings](#)

Device Settings

Check the battery status and configure the settings of the device.

- 1 Press the [Menu] button.**
- 2 Use the [←]/[→] buttons to select [Settings] and then press the [Confirm] button.**

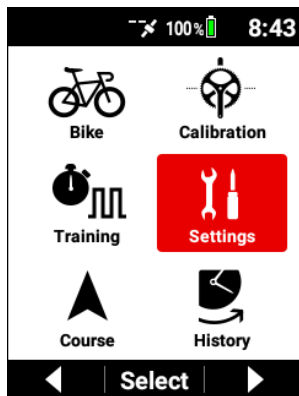

- 3** Use the [←]/[→] buttons to select [Device] and then press the [Confirm] button.

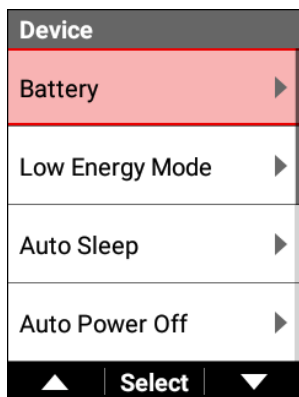
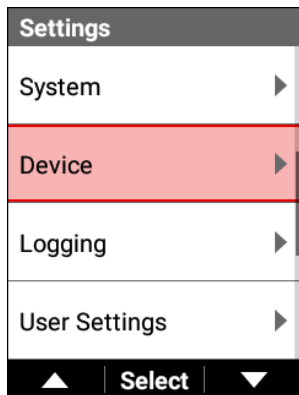

Setting item	Description
Battery	You can check the battery level.

Low Energy Mode	<p>Enable* or disable the power saving mode and set a battery threshold value.</p> <p>When the power saving mode is enabled, if the remaining battery level drops to below the threshold value, a message appears and then the device switches to the power saving mode after approximately 10 seconds.</p> <p>The settings are automatically adjusted so that the possible operating time becomes longer.</p> <p>In power saving mode, Bluetooth connection does not function and LCD does not display information.</p> <p>Turn on the LCD display by pressing any button other than [←] and [→].</p> <p>The factory setting is [10%].</p>
Auto Sleep	<p>Enable* or disable auto sleep and set the time until auto sleep.</p> <p>When auto sleep is enabled, if there is no button operation or riding within the set time before logging starts or during auto pause, a message appears and then the device sleeps after approximately 10 seconds.</p> <p>When the auto power off setting is enabled, if the sleep state continues within the set time, the power is automatically turned off from the sleep state.</p> <p>The device will wake up automatically when the power value or cadence value of the pedaling monitor, ANT+power meter, or ANT+smart trainer becomes valid.</p> <p>When it becomes valid, the device may take a while to wake up if it has been asleep for one minute or more.</p>
Auto Power Off	<p>Enable* or disable auto power off and set the time until auto power off.</p> <p>When auto power off is enabled, if there is no button operation or riding within the set time, a message appears and then the device powers off after approximately 1 minute.</p>
Altitude Calibration	<p>Enable* or disable auto GPS altitude correction and set the correction method (current altitude*/sea level pressure/GPS).</p> <p>You can also check the current altitude.</p> <p>Calibration can also be performed manually.</p>

Note

- If the remaining battery power is at the threshold value or lower immediately after the device starts up in the state in which the power saving mode is enabled, a message appears and then the device switches to the power saving mode after approximately 10 seconds.
- If you charge the battery in the power saving mode, the power saving mode will be canceled.
- If you press the [Menu] button within 10 seconds after the LCD turns on in the power saving mode, the "Disable Low Energy Mode?" message appears.
If you select [OK] and then press the [Confirm] button, the power saving mode is canceled, the power saving mode setting is disabled temporarily, and the main menu appears. If the power of the device is turned off, the power saving mode will be enabled again.
- Auto pause, auto sleep, and auto power off operate also in the power saving mode.
- Even if auto power off is enabled, the device does not power off while log data is being uploaded.
The device will power off after uploading ends.
- When the GPS receives 3D positioning information before logging starts, during auto pause (or a state equivalent to auto pause when the auto pause function is disabled), and after log data saving, the auto GPS altitude correction function automatically compares the altitude value obtained from the GPS with the current altitude and corrects the altitude if the difference is large.
This enables altitude errors due to, for example, climatic changes to be corrected automatically.

Wi-Fi Settings

Configure settings related to Wi-Fi such as switching the Wi-Fi connection and adding an access point.

- 1** Press the [Menu] button.

- 2 Use the [←]/[→] buttons to select [Settings] and then press the [Confirm] button.

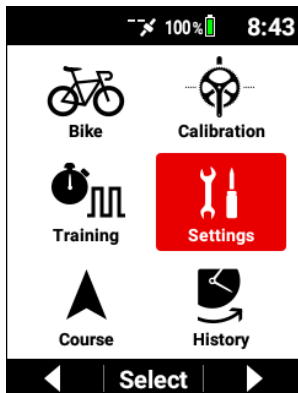

- 3 Use the [←]/[→] buttons to select [Wi-Fi Settings] and then press the [Confirm] button.

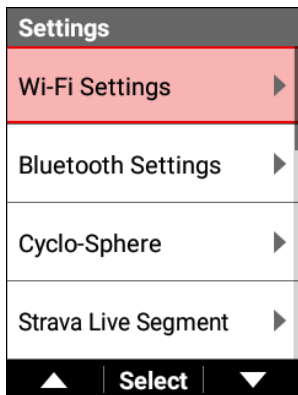

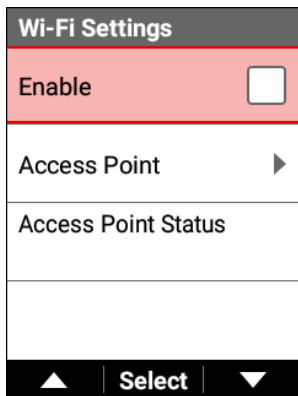

Setting item	Description
Enable	Enable or disable* W-Fi connections.
Access Point	<p>Display a list of the access points that the device can detect.</p> <p>Use the [←]/[→] buttons to select a connection destination and then press the [Confirm] button.</p> <p>The "Select operation." message appears.</p> <p>To connect, press the [Confirm] button.</p> <p>The first time the device attempts to connect, the screen switches to the password input screen.</p> <p>If there is connection history, the device will connect.</p> <p>To delete the access point information, press the [→] button.</p> <p>The password and other information of the access point are deleted.</p>
Access Point Status	Display the status of the connected access point.

Note

- The device supports the "WEP" and "WPA/WPA2 PSK" standards.

- The device does not support the stealth function of wireless LAN routers and wireless LAN access points.
Routers and access points with the stealth function enabled are not displayed in the connection list of the device.
- The device cannot connect to an access point that requires entering the account information using a web browser.

Bluetooth Setting

Set which items (functions) to use Bluetooth for.

Up to 4 Bluetooth connections are possible and the channels can be enabled or disabled according to the purpose of use.

The current Bluetooth connection status is also displayed.

Note

- If a connection with a smartphone is not possible or is unstable, check the following.
 - Update the firmware of the device to the latest version and update the Cyclo-Sphere Control App to the latest version.
 - Display the Cyclo-Sphere Control App in the foreground while the device is running and check that the device becomes connected.
 - Exit the Cyclo-Sphere Control App and then start it again.
The exit procedure differs depending on the OS used.
Example: In the case of iPhone 8 running iOS 12, tap the home button twice and then swipe the Cyclo-Sphere Control App upward.
 - Turn the Bluetooth function in the Bluetooth screen of the OS settings off and then back on.
 - If the “There is a possible Bluetooth error. Turn off Bluetooth in settings, then turn back on to re-boot.” message is displayed in the Cyclo-Sphere Control App, turn the Bluetooth function in the Bluetooth screen of the OS settings off and then back on.
 - Delete the device name of this device (P-*****, where the asterisks are the last six digits of the serial number on the back of the device) from your devices displayed in the Bluetooth screen of the OS settings. (iOS only)
 - The connection may become stable if you reduce the number of registered Bluetooth devices from your devices displayed in the Bluetooth screen of the OS settings.
 - To use the Bluetooth function with an Android device, you need to configure access rights to the Cyclo-Sphere Control App location information on the Android device, and turn the location information on.
 - Stable operation may not be possible if there is interference from radio waves in the 2.4 GHz band emitted from a nearby microwave oven or a Wi-Fi or other device, so check the connection in a environment with a good signal.
 - Delete this device from the device list of the Cyclo-Sphere Control App and then add it with [Ajouter un nouvel appareil] again.
 - Restart your smartphone.
 - Reinstall the Cyclo-Sphere Control App.

1 Press the [Menu] button.

- 2 Use the [←]/[→] buttons to select [Settings] and then press the [Confirm] button.

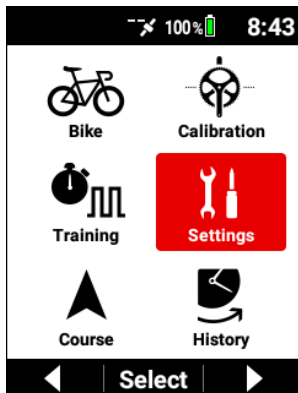

- 3 Use the [←]/[→] buttons to select [Bluetooth Setting] and then press the [Confirm] button.

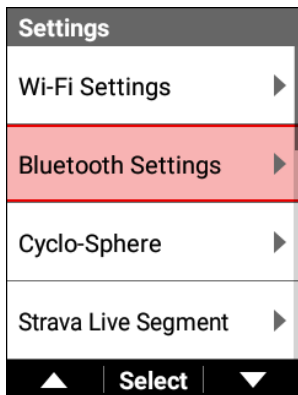

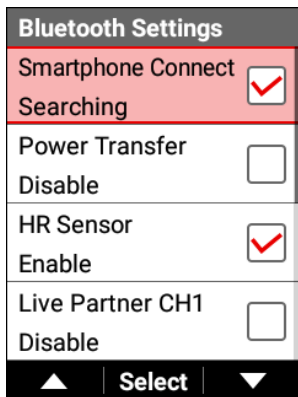

Setting item	Description
Smartphone Connect/ Power Transfer/HR Sensor/Live Partner CH1/Live Partner CH2/ Live Partner CH3	Enable or disable the items (functions) to be used. Up to four items can be enabled. [Smartphone Connect], [HR Sensor] are enabled by default. The setting of [Smartphone Connect] is always valid and can not be changed.

Note

- If [HR Sensor] is disabled, the Bluetooth heart rate sensor will not appear in the list when adding a sensor.

Linking with External Services

Strava

You can synchronize the routes and segments that you created in Strava using the Cyclo-Sphere Control App on your iPhone or Android device and then import them for use on the device.

You can use the log data auto transfer function by using the Cyclo-Sphere Analysis App or Cyclo-Sphere of the web service.

Ride with GPS

You can synchronize the routes that you created in Ride with GPS using the Cyclo-Sphere Control App on your iPhone or Android device and then import them for use on the device.

There is no function to transfer the log data to Ride with GPS.

Upload the log data to Cyclo-Sphere and then download it as a FIT file and upload the file to Ride with GPS.

TrainingPeaks™

You can send the training menus (workouts) that you created in the TrainingPeaks service using the Cyclo-Sphere Control App on your iPhone or Android device and then import them for use on the device.

You can use the log data auto transfer function by using the Cyclo-Sphere Analysis App or Cyclo-Sphere of the web service.

ZWIFT

You can enjoy rides in a virtual space in ZWIFT by connecting a power meter or speed sensor to the PC ZWIFT application or the iPhone or Android device ZWIFT application.

This device allows you to transmit the power values of pedaling monitor sensors to the ZWIFT application by using the ANT+ power transmission function or Bluetooth power transmission function. To use the Bluetooth power transmission function, configuration of the Bluetooth setting on the device is required.

Smartphone Notification Function

The device communicates with the Cyclo-Sphere Control App on your iPhone or Android device and then displays the notification information received from the smartphone.

This allows you to see notifications for received iMessage and other messages, incoming calls, received social media-related messages, schedule events, and received e-mail.

The receiving of each notification type can be enabled or disabled from the Cyclo-Sphere Control App.

A-GPS Function

This device supports A-GPS (Assisted GPS) for acquiring GPS, GLONASS, and Michibiki satellite signals.

The time required to determine the position of your bike immediately after startup is significantly improved by transferring the satellite information via the Cyclo-Sphere Control App to acquire satellite positions at high speed.

The A-GPS function can be enabled or disabled from the Cyclo-Sphere Control App.

Note

- The effectiveness of this function increases if a GPS signal has not been received for at least one week.
- When this function is used, it has no effect on the possible operating time.

Frequently Asked Questions

Answers to questions frequently asked by customers are provided below.

Q: How can I return the language setting to English?

A: You can change the language in [Language] of the system settings.

System Settings

Q: The vectors of the pedaling graph are not displayed. Is there a problem with the display?

A: Try performing magnet calibration.

Magnet calibration

Q: Error 13 occurred during zero calibration. What does this error mean?

A: Sudden changes in the temperature are occurring.

Wait a while for the temperature to become stable and then perform zero point calibration again.

Q: The operation buttons have become completely inoperable. Why?

A: Operation may have become impossible for some reason.

Try performing a forced reset by pressing and holding the [Power/Logging] button for 10 seconds or more.

Do not perform a forced reset when there is no problem with the device. Doing so may cause a failure

Q: How do I upload log data?

A: There are three ways to upload log data.

- ① Upload via Wi-Fi from the [Cyclo-Sphere] menu item of the device.

- ② Connect the device to your PC and then upload from the upload button of Cyclo-Sphere.
- ③ Use the Cyclo-Sphere Control App on your iPhone or Android device to transfer the log data from your device using Bluetooth and then upload the log data using your phone line or Wi-Fi.

Uploading Log Data

Q: Can you tell me how the time is set?

A: An automatic update is performed for the clock of the device when a GPS signal is received before logging starts or after log data is saved.

However, if the time zone setting is incorrect, the correct time may not be displayed.

The time zone and time can be set in [Date & Time] of the system settings.

System Settings

The time zone can also be set automatically using the Cyclo-Sphere Control App, which is an app for smartphones.

For details, refer to the following website.

<https://cyclo-sphere.com/app/>

Q: Why can I not connect with my smartphone via Bluetooth?

A: Check the Bluetooth settings.

Bluetooth Setting

Appendix

Cautions Regarding Care, Storage, and Disposal

■ About Care and Storage

Make sure that the power of the device is turned off before cleaning.

- When wiping off dirt from the display, use a commercial cleaning cloth to gently clean the display.
- Use a soft dry cloth or a cloth that has been dampened and wrung out to wipe the device or the bracket.
- Do not use benzene, thinner, or other volatile chemicals, detergent, or chemically treated cloths.
Doing so could damage the product or cause the paint to peel.
- When storing the device for a long period of time, discharge the battery and store the device in a cool and dark place.

■ About Disposing of the Device

When disposing of the device, remove the lithium-ion battery and then dispose of the device in accordance with the rules and regulations of the local government where you live.

Do not dispose of the removed lithium-ion battery but instead take it to a place that accepts rechargeable batteries for recycling.

■ Replacing the Lithium-Ion Battery

Do not replace the lithium-ion battery yourself.

Consult with a repair center. (Battery replacement is a service provided for a fee.)

■ Cautions When Recycling

The device uses a lithium-ion battery.

Lithium-ion batteries contain precious resources that can be recycled.

Do not dispose of the lithium-ion battery but instead take it to a place that accepts rechargeable batteries for recycling.

For safety, affix cellophane tape or the like to the battery lead wire terminals beforehand.



Li-ion

Remove the lithium-ion battery by the following procedure.

Caution

- When removing the battery from the device, be careful not to injure yourself with a tool, etc.
Please never attempt to disassemble the device other than to dispose of the battery.

- 1 Remove the four screws with a Phillips screwdriver and then insert a flat-blade screwdriver from the groove at the front and use it to raise up the back cover.**

When removing the screws of the USB connector cover, take care not to deform the screw drive.

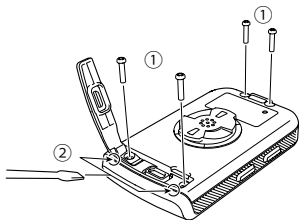

- 2 Disconnect the cable of the lithium-ion battery from the board and detach the entire board from the front.**

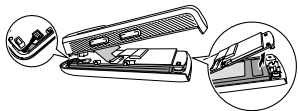

When disconnecting the lithium-ion battery cable, please hold and pull the connector without pulling the cable part.

Pulling the cable part may cause a disconnection.

3 Insert a finger from the side direction of the lithium-ion battery and peel off the tape.

Peel off the tape that secures the lithium-ion battery to remove the battery.

Be careful not to damage the lithium-ion battery.

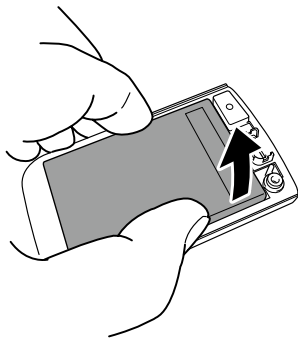

4 Remove the lithium-ion battery from the back cover.

Dispose of the device with the battery removed in accordance with the rules and regulations of the local government where you live.

Warranty and After-Sales Service

- Warranty card

Check that the date of purchase, store name, and other information have been filled in on the warranty card when you receive it from the store at the time of purchase.

The warranty will be invalid even during the warranty period if any information has not been filled in on the warranty card or if you lose the warranty card.

Carefully read the details of the warranty card and then store it in a safe place.

- Warranty period

The warranty period of this product is one year from the date of purchase.

- About repairs during the warranty period

In the event that a failure occurs, Pioneer will repair the product in accordance with the Pioneer warranty provisions described on the warranty card.

Consult with the store where you purchased the product.

If making a request to the store is difficult, consult with a repair center.

- About repairs after the warranty period expires

Consult with the store where you purchased the product. If making a request to the store is difficult, consult with a repair center.

A product that will be able to be used if repaired will be repaired for a fee upon request.

- Minimum retention period of performance parts for repair

Pioneer retains performance parts to repair the device for a minimum of six years after the discontinuation of production.

(Performance parts are parts that are required to maintain the functions of the product.)

For questions or consultation regarding the device, contact a Pioneer service center or the place of purchase.